

Milano II / Milano II G

DIGITAL PIANO

OWNER'S MANUAL



IMPORTANT SAFETY INSTRUCTION

IMPORTANT SAFETY INSTRUCTIONS

CAUTION: Use of controls or adjustments or performance of procedures other than those specified herein may result in hazards radiation exposure.

Please carefully study this manual and always keep it available. There are, however, some installation and operation precautions which should be aware of:

- 1) Read these instructions.
- 2) Keep these instructions.
- 3) Heed all warnings.
- 4) Follow all instructions.
- 5) Do not use this apparatus near water.
- 6) Clean only with dry cloth.
- 7) Do not block any ventilation openings. Install in accordance with the manufacturer's instructions.
- 8) Do not install near any heat sources such as radiators, heat registers, stoves, or other apparatus (including amplifiers) that product heat.
- 9) Do not defeat the purpose of the polarized or grounding-type plug. A polarized plug has two blades with one wider than the other. A grounding type plug has two blades and a third grounding prong. The wide blade or the third prong are provided for your safety. IF the provided plug does not fit into your outlet, consult an electrician for replacement of the obsolete outlet.
- 10) Protect the power cord from being walked on or pinched particularly at plugs, convenience receptacles, and the point where the exit from the apparatus.
- 11) Only use the attachments/accessories specified by the manufacturer.
- 12) Use only with the cart, stand, tripod, bracket, or table specified by the manufacturer, or sold with the apparatus. When a cart is used, use caution when moving the cart/apparatus combination to avoid injury from tip-over.



Figure 17.016. Do not use cart

- 13) Unplug this apparatus during lightning storms or when unused for long periods of time.
- 14) Refer all servicing to qualified service personnel. Servicing is required when the apparatus has been damaged in any way such as power supply cord or plug is damaged, liquid has been spilled or objects have fallen into the apparatus, the apparatus has been exposed to rain or moisture, does not operate normally, or has been dropped.
- 15) Apparatus shall not be exposed to dripping or splashing and no objects filled with liquids, such as vases, shall be placed on the apparatus.
- 16) Warning - To reduce the risk of fire or electric shock, do not expose this apparatus to rain or moisture.

GENERAL PRECAUTIONS

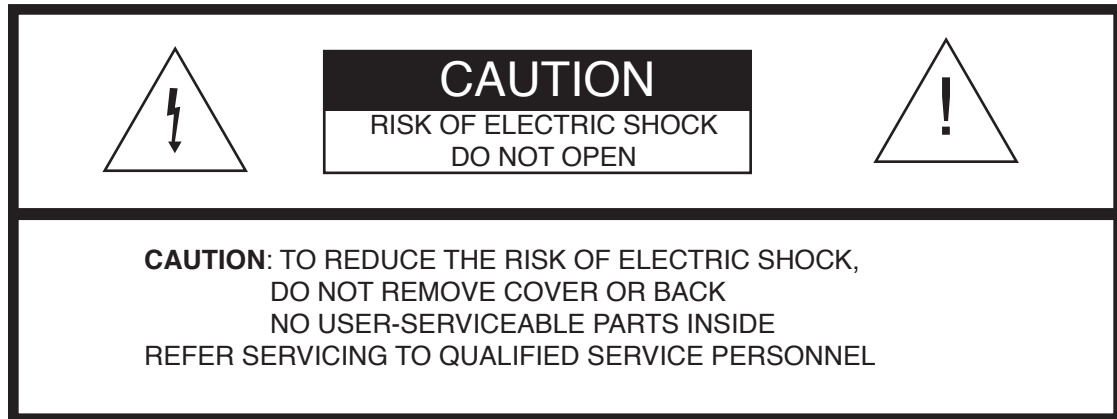

INSTRUCTIONS PERTAINING TO A RISK OF FIRE, ELECTRIC SHOCK OR INJURY:

The lightning flash with arrowhead symbol, within an equilateral triangle, is intended to alert the user to the presence of uninsulated or “dangerous voltage” within the product’s enclosure that may be of sufficient magnitude to constitute a risk of electric shock to persons.

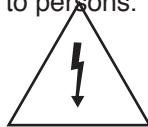

The exclamation point within an equilateral triangle is intended to alert the user to the presence of important operation and maintenance or servicing instructions in the manual accompanying the product.



1. **CAUTION:** Any changes or modifications in construction of this device which are not expressly approved by the party responsible for compliance could void the user’s authority to operate the equipment.
2. **NOTE:** This equipment has been tested and found to comply with the limits for a Class B digital device, pursuant to Part 15 of the FCC Rules. These limits are designed to provide reasonable protection against harmful interference in a residential installation. This equipment generates, uses, and can radiate radio frequency energy and, if not installed and used in accordance with the instructions, may cause harmful interference to radio communications. However, there is no guarantee that interference will not occur in a particular installation. If this equipment does cause harmful interference to radio or television reception, which can be determined by turning the equipment off and on, the user is encouraged to try to correct the interference by one or more of the following measures :
 - Reorient or relocate the receiving antenna.
 - Increase the separation between the equipment and receiver.
 - Connect the equipment into an outlet on a circuit different from that to which the receiver is connected.
 - Consult the dealer or an experienced radio/TV technician for help.”

TAKE CARE OF YOUR PIANO

This digital piano will supply you with years of musical enjoyment if you follow the simple rules listed

WARNING

When using electrical products, basic safety precautions should always be followed, including the following:

SAFETY

Power Source - The product should always be connected to a power supply only of the type described in the operating instructions or as marked on the product.

Periods of Nonuse - The power-supply cord of the product should be unplugged from the outlet when left unused for a long period of time.

SERVICE AND MODIFICATION

This product should be serviced by qualified service personnel when,

- the power supply cord or the plug has been damaged,
- liquid has been spattered into the unit or it has been exposed to rain,
- the instrument does not appear to operate normally or exhibits a marked change in performance.
- the instrument has been dropped or the cabinet has been damaged.
- Do not attempt to open the piano or make any change in the circuits or parts of the unit.

HANDLING AND TRANSPORT

- Never apply excessive force to the controls, connectors or other parts of the instrument.
- Always unplug cables by gripping the plug firmly, not by pulling on the cable.
- Disconnect all cables before moving the instrument.
- Physical shocks caused by dropping, bumping, or placing heavy objects on the instrument can result in scratches and/or more serious damage.
- Carefully check the amplifier volume control before starting to play. Excessive volume can cause permanent hearing loss.

CLEANING

- Clean the cabinet and panel with a soft non-abrasive dry cloth. This cloth should be for High Gloss Lacquer Finish Furniture. A wax based polish specifically for High Gloss Lacquer Finish Furniture may be used on the cabinet. Do not use paint thinner or petrochemical based polishes.

For Veneer Style Wood finish a standard polish is "pledge" is acceptable.

- To maintain the luster of the keys and buttons wipe with a clean, slightly damp cloth, and then polish with a soft dry cloth.

LOCATION

Do not expose the instrument to the following conditions to avoid deformation, discoloration, or more serious damage:

- direct sunlight (near a window)
- high temperatures (near a heat source, outside, or near a window)
- rain or excessive humidity
- excessive dust
- strong vibration
- Leave enough space around the piano for it to be properly ventilated.
- This instrument contains digital circuitry and may cause interference if placed too close to radio or television receivers. If interference occurs, move the instrument further away from the affected equipment.
- Avoid placing vinyl objects on top of the instrument, vinyl can stick to and discolor the surface.
- The instrument shall not be exposed to dripping or splashing and no objects filled with liquids, such as vases, shall be placed on the instrument.

POWER

- The instrument should be placed where it is easy to unplug the power plug
- The instrument is unplugged the power plug during lightning storm, cleaning or not unused for long periods of time.
- Turn the power switch off when the instrument is not in use.
- To avoid damage to the instrument and other devices to which it is connected, turn the power switches of all related devices off prior to connection or disconnection of MIDI cables.
- Turn the power off if the main cable is damaged or the instrument is spattered with liquid.
- Do not switch the unit on and off in quick succession, this places an undue load on the electronic components.
- Avoid plugging the AC power cord into the same AC outlet as appliances with high power consumption, such as electric heaters or refrigerators.

TABLE OF CONTENTS

ASSEMBLY	7
PANEL CONTROLS	13
DEMO	23
KEYBOARD VOICES	24
Voice Selection	24
Layer (dual)	25
Lower (split)	25
RHYTHM SECTION	27
Rhythm Style Select	27
Adjusting the Tempo	28
Starting and Stopping the Rhythm Style.....	29
Variation	30
Fill-In	30
AUTO ACCOMPANIMENT (AUTO BASE CHORD)	31
Single	31
Fingered	32
Piano	33
Manual Bass Chord	33
Auto Harmony	33
Starting and Stopping the Auto Accompaniment	34
Variation	35
Fill-In	35
Metronome	35
USB FLASH DRIVE	36
Enter the USB Flash Drive mode	36
save	37
Play all songs	39
load	39
Solo	43
Mute	44
Delete	44
FUNCTION	47
Drum Kit Selecting (Keyboard Percussion)	47
Reverb Level	47
Chorus Level	48
Touch Response	48
Split Point for Lower Voice	49
Split Point for Auto Accompaniment	49
Auto Harmony Type Selecting	50
Master Tune	50
Equalization	51
Reverb Type1	51
Chorus Type	52
Vocal Grading	52
Local	52
Factory Setting	52

TABLE OF CONTENTS

RECORD	53
Recording	53
Playback	54
REGISTRATION MEMORY	56
PLAY ALONG SONGS	57
IPOD DOCK	57
MIDI	59
MIDI IMPLEMENTATION CHART	62
VOICE LIST	63
STYLE LIST	66
DRUM KIT LIST	67
PEDALS	70
SPECIFICATIONS	71

ASSEMBLY

Milano IIG

Take off the piano body from the packing carton.

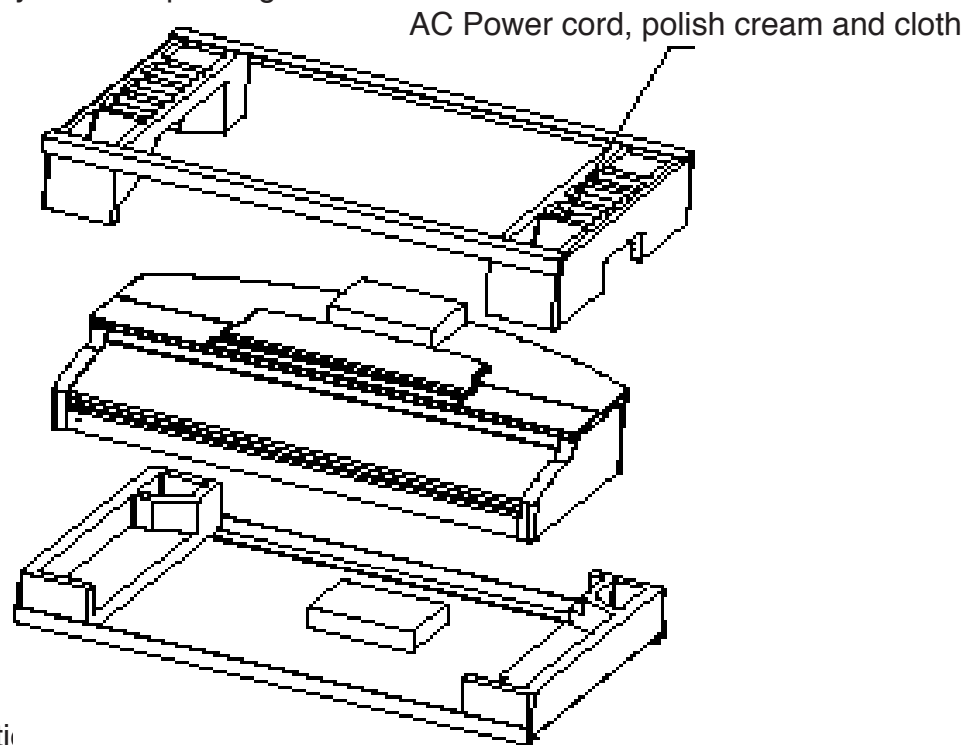

Hardware for installation.....

Power Chord	1
Philips Screw Driver	1
Wrench	1
Tapped Screw 4X10 (Brass)	8
Bolt M8X45	16
Washer 8	16
Spring washer 8	16

Take off the pedal assembly and piano legs from the packing carton.

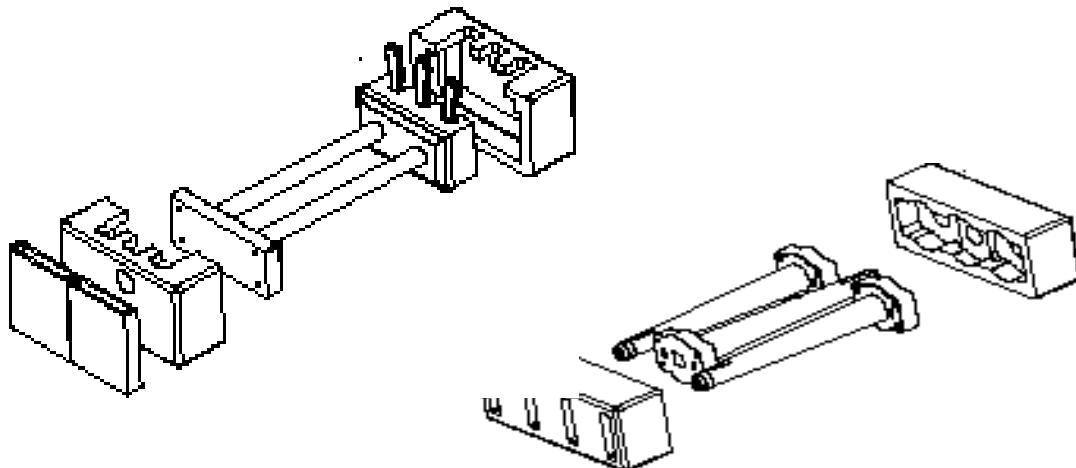

ASSEMBLY

Install legs and the pedal assembly to the bottom of the piano with bolt, washer and spring washer. Tighten the bolts using wrench provided.

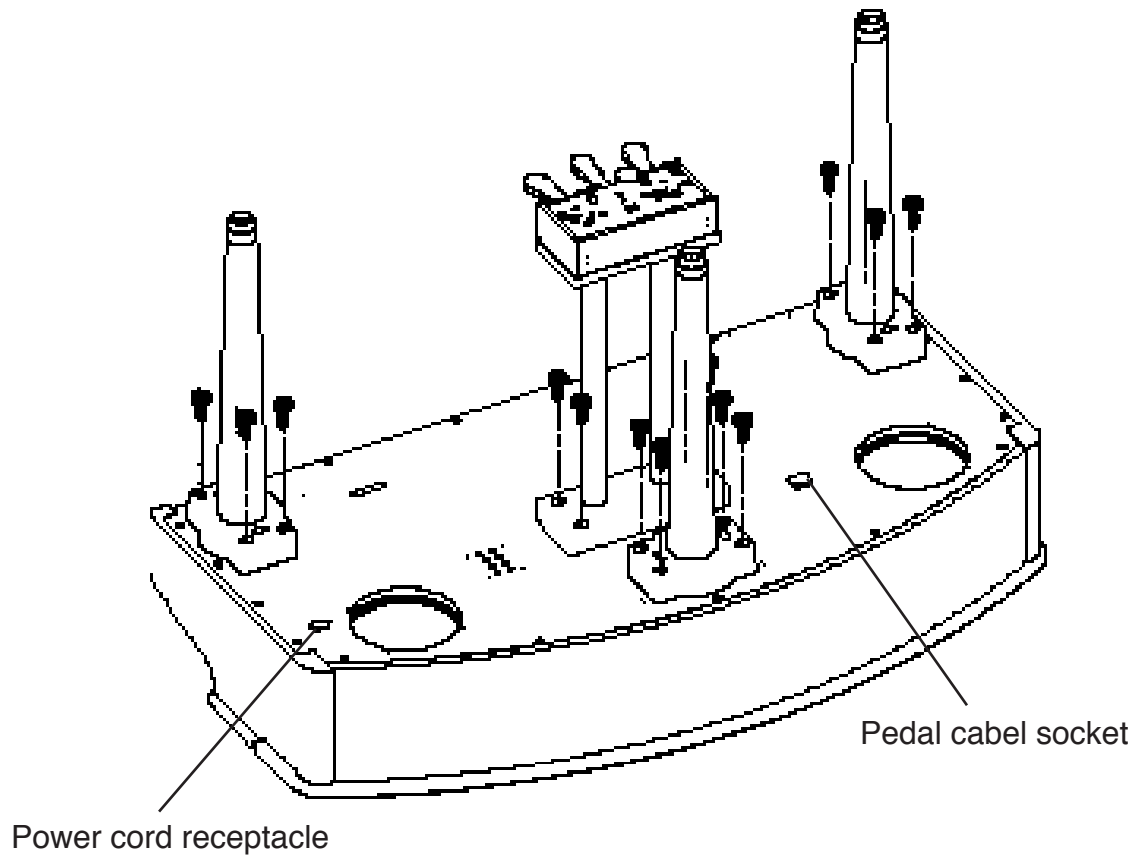

Plug pedal cable into the cable socket in the bottom of the piano.

ASSEMBLY

Install the pedal support rods by tapped screws.

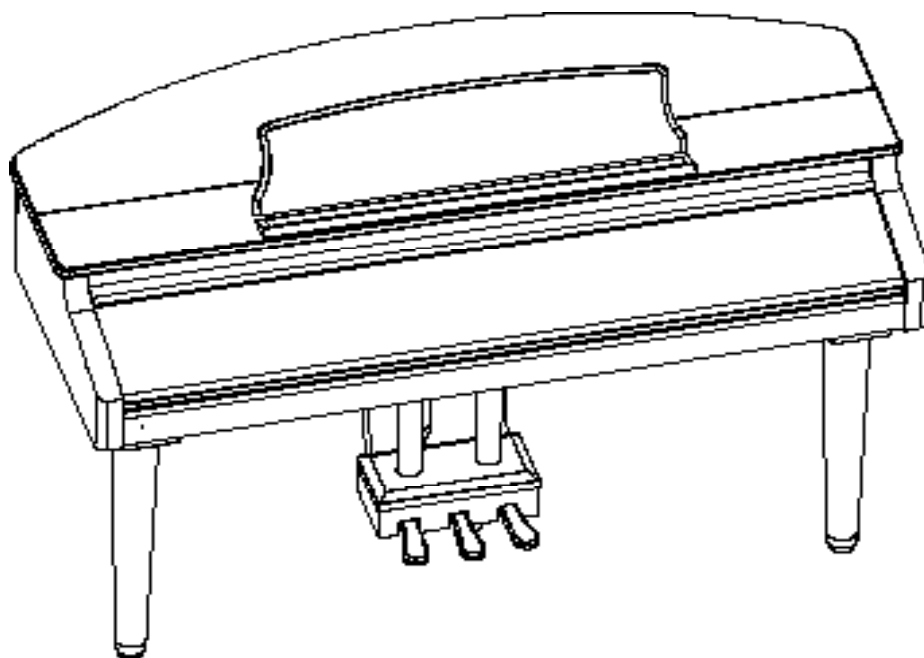
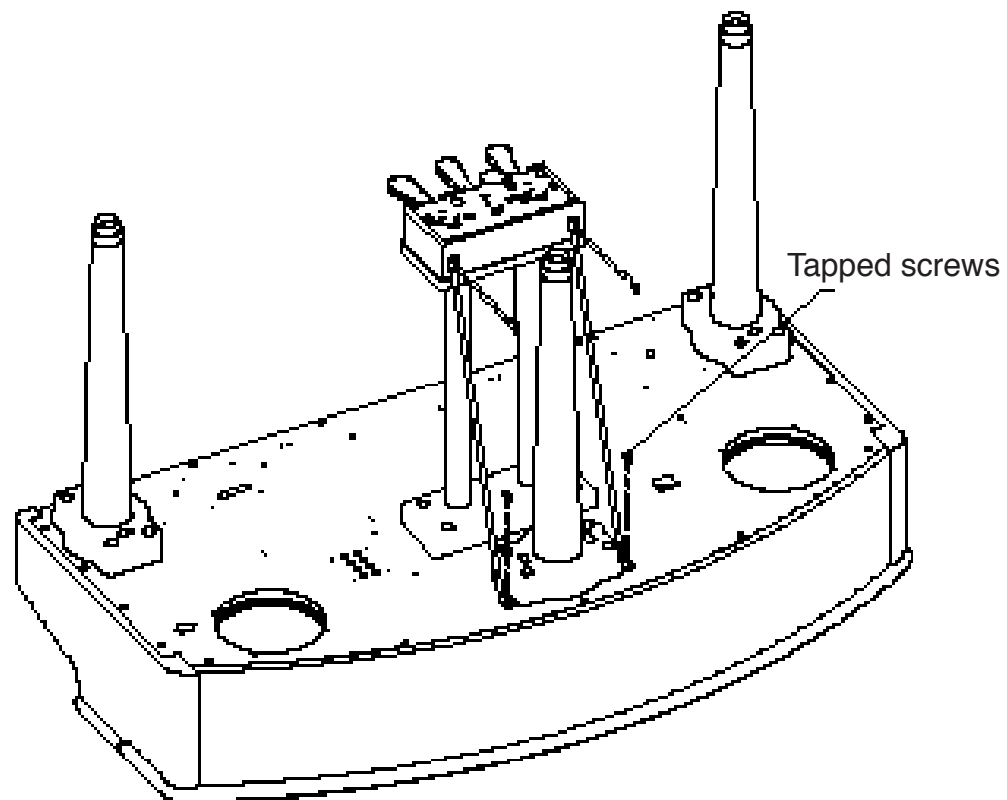

Plug pedal cable into the cable socket in the bottom of the piano.

ASSEMBLY

Place the piano in its final position, on the bottom the pedal board is a turn down knob. Turn the Knob down to firmly touch the floor.

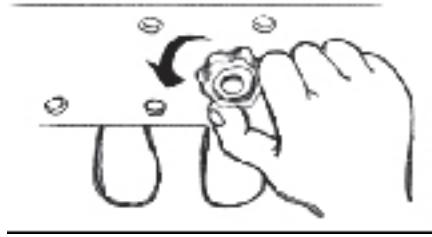

Locate the Power Cord and plug it into the Receptacle on the bottom of the Piano. Plug the Power Cord into an appropriate wall socket.



ASSEMBLY

Milano II

You have hardware for installation in the accessory bag listed below:

(1) Screw M6X20 (10 pcs)

(2) Screw M6X15 (4 pcs)

(3) Self-Tapping Screw 4X16 (6 pcs)

(4) Self-Tapping Screw 4X12 (2 pcs)

1. **LAYING THE PEDAL CABEL** - Take off the cover of the cabel slot. Lay in the pedal cabel, then insert the cover.

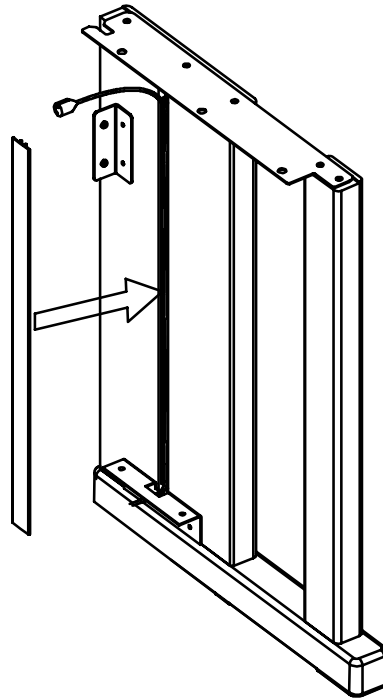

2. **CROSS BAR INSTALLATION** - Fix the pedal cross bar to the leg with the screw (1).

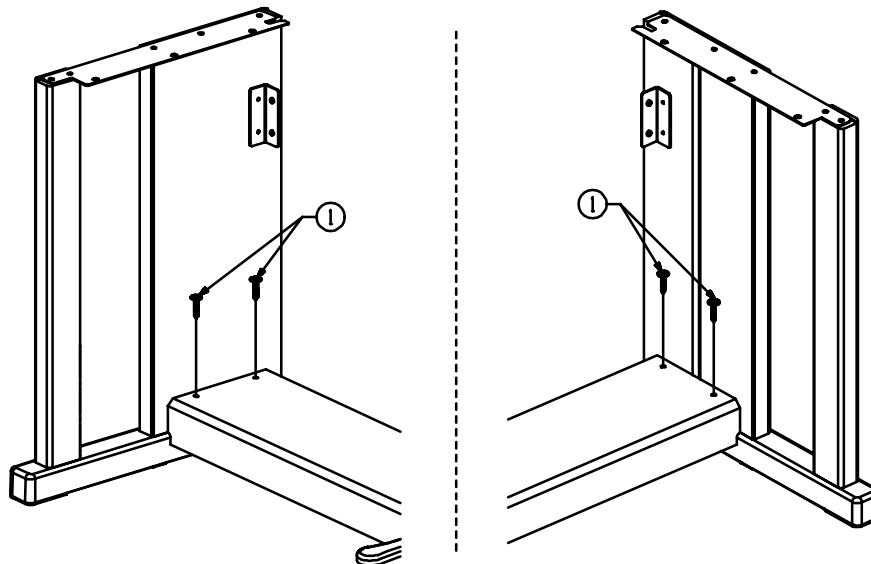

ASSEMBLY

3. **BACK BOARD INSTALLATION** - Fix the back board to the legs with the screw (3).

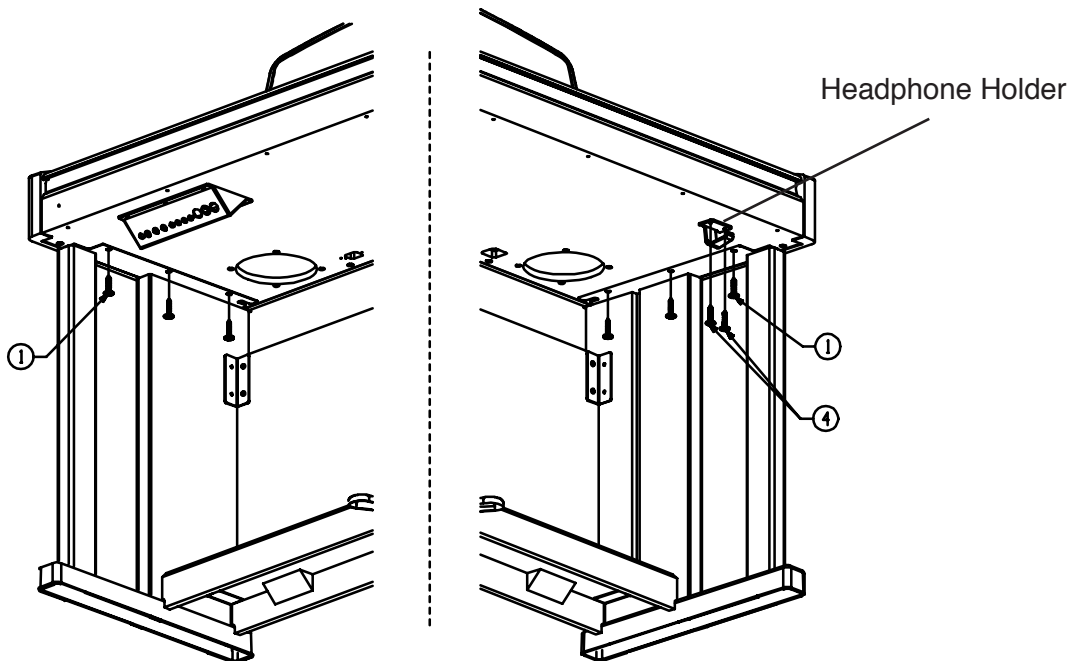
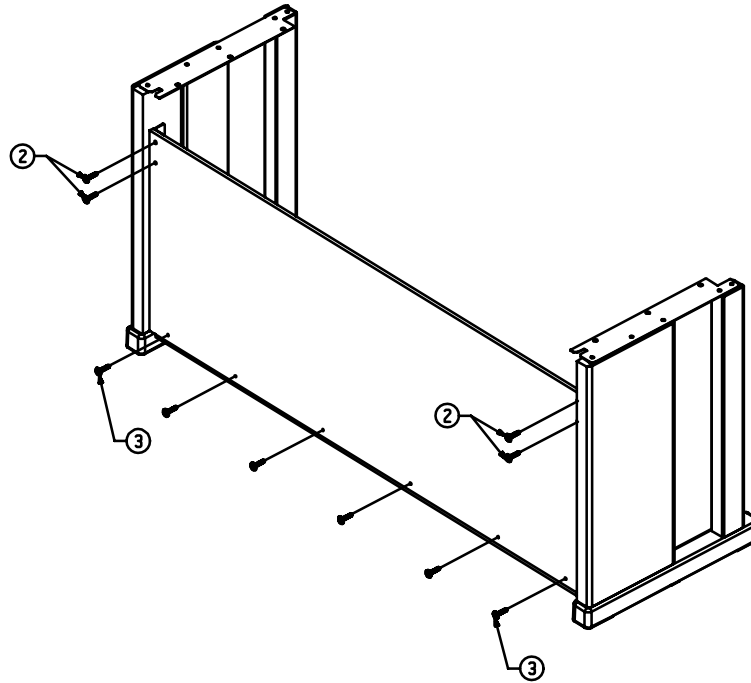

5. **POWER SUPPLY CONNECTION** - Plug the the power cord into the receptacle located on the bottom of the piano. Plug the 3-pin plug in the another end of the cord to the AC wall outlet.



CONNECTOR PANEL

This connector panel, with its various jacks, is located on the bottom left of the piano, under the keybed.

1

2

3

4

5

MIC



1

Microphone - Plug in a microphone to sing song with piano playing.



2.

PHONE 1 / PHONE 2 - You can play in total silence, without disturbing others in the room, by plugging a set of headphones into one of the appropriate sockets. When headphones are plugged into either of these jacks the main speaker system is turned off. Two sets of headphones may be used simultaneously.

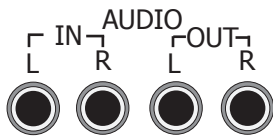

3

LINE IN - These stereo audio input jacks will amplify the supplied signal through the internal sound delivery system. They can be used to hook up items such as CD players, MP3 player or Cassette player.

LINE OUT - These stereo audio output jacks supplies the piano's output signal to external amplification, such as home stereo, PA system or other stand alone amplifiers.

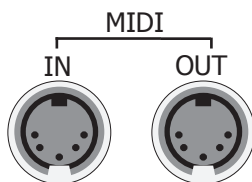

4

MIDI IN / MIDI OUT - This piano contains MIDI in and MIDI output ports. MIDI jacks allow communication with other products equipped with MIDI interfaces. Please see the MIDI section of this manual for further details.

USB



5

USB - The USB connector allows you to connect the piano directly to your computer. The piano can be connected with computer without driver installation under the Windows XP environment. The piano could be recognized as USB Audio device to receive and transmit MIDI message.

PANEL CONTROLS

The elegant control panel is divided into several distinct sections. The following is a brief description of all the features located on the control panel.

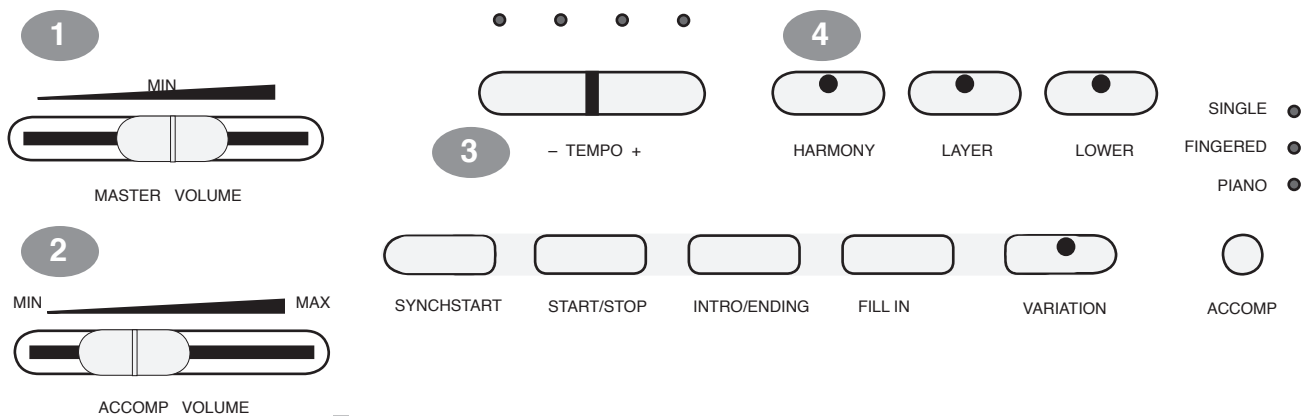

1. **MASTER VOLUME** - Use this sliding control button to adjust the overall volume of the keyboard.
2. **ACCOMP VOLUME** - Slide this controller to adjust the volume of the auto accompaniment and metronome, the keyboard instrument voice will not be affected.
3. **TEMPO** - Press one of the TEMPO buttons, the current tempo value will appear on the display. You can use the TEMPO +, TEMPO – buttons, or the +/YES and –/NO buttons to change the tempo value range from 40 to 240 bpm (beats per minute). Press the TEMPO + or TEMPO – buttons or the +/YES and –/NO buttons simultaneously to recall the default tempo setting for the selected rhythm style. After three seconds the display will revert to the selected voice. There is a four-dot beat indicator above the tempo buttons. It indicates the tempo and beat for the accompaniment that is playing.
4. **HARMONY** - When selected, the single note played on the right-hand section of the keyboard will sound with additional auto harmony notes. The note played in the upper section of the piano determines the root key of the harmony. It is recommended that one note be played at a time. If more than one note is played only the highest note will add harmony. **Auto harmony is only available when the auto accompaniment is engaged.** The harmony type selection is assigned in the Function menu. Use it to select the type of harmony, Duet, Close Harmony, Open Harmony, or Octave. See the Function section for more information.

PANEL CONTROLS

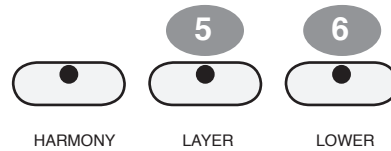
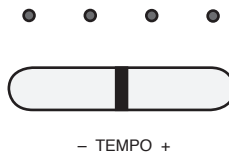
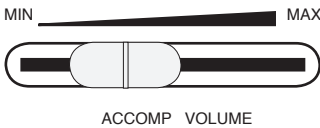
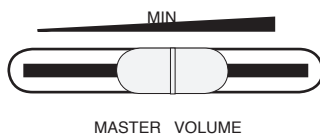

SINGLE ●
FINGERED ●
PIANO ●

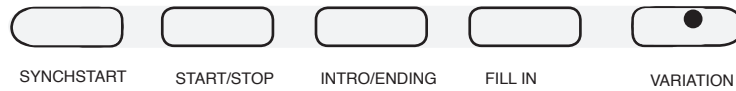

5. **LAYER** - Engaging the LAYER button will put the keyboard in the layer, or dual, mode. Layer, or dual, refers to an additional voice that is tone mixed with the selected keyboard voice. The assigned layer voice will be heard with the original voice. To select a new layered instrument voice use the +Yes or -No buttons within 4 seconds after the Layer button has been engaged.
6. **LOWER** - With the LOWER feature engaged the keyboard operates in the split mode. In the split mode the keyboard is divided into two sections. In the right hand section the original or layered voice will sound, and in the left hand section a different voice can be assigned to sound when the keys are played. To select a new Lower instrument voice use the +Yes or -No buttons within 4 seconds after the Lower button has been engaged.
7. **SYNC START** - Synchronized Start mode sets the auto accompaniment into standby mode. When the SYNC START button is pressed the indicator lights above the tempo will flash to the Tempo of the selected rhythm style. **The rhythm style will start as soon as you play in the auto accompaniment section of the keyboard.** The auto accompaniment will start with the first recognized chord played in the auto accompaniment section of the keyboard, depending on which fingering mode is selected. Pressing the SYNC START button again will stop the auto accompaniment and put the keyboard back on standby mode.
8. **START/STOP** - This button starts or stops the selected rhythm style. The auto accompaniment will start with the first recognized chord played in the auto accompaniment section of the keyboard, depending on the fingering mode selected.

PANEL CONTROLS

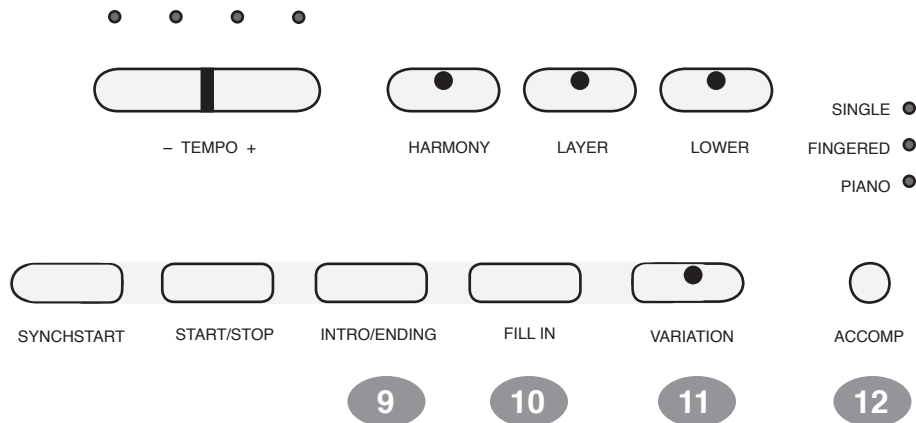

9. **INTRO/ENDING** - All of the 100 rhythm styles can be started or finished with an detailed individual introduction or ending pattern. When engaged, an introduction of rhythm pattern will start followed by the main pattern.
With a rhythm or accompaniment pattern already engaged the accompaniment can be professionally completed with an ending pattern from the next measure by pressing the INTRO/ENDING button. If you press the fill-in button during the ending pattern it will return to the main accompaniment pattern.
10. **FILL IN** - The fill-in provides the accompaniment with a short rhythm pattern of one or two measures for each style. Press the FILL IN button at any time while the accompaniment is playing to add a fill-in. If you hold down the FILL IN button, the fill-in pattern will repeat until the button is released, then the main pattern will play from the beginning of the next measure.
11. **VARIATION** - All of the 100 rhythm styles include a variation of that style that can be played simply by engaging the VARIATION button. Press the VARIATION button again to disengage and return to the main pattern.
12. **ACCOMP** - Each rhythm style has a fully orchestrated auto accompaniment pattern. These accompaniments are dedicated to the selected rhythm style, and will create rhythm, bass and chord accompaniments. The ACCOMP button selects the auto accompaniment mode. With this function engaged, the keys to the left side of the split point are the auto accompaniment section of the keyboard, while the keys to the right are available for normal playing.
The auto accompaniment fingering modes are single, fingered, piano, and off. Press the ACCOMP button until the indicator LED that corresponds to the fingering mode you desire turns on.

PANEL CONTROLS

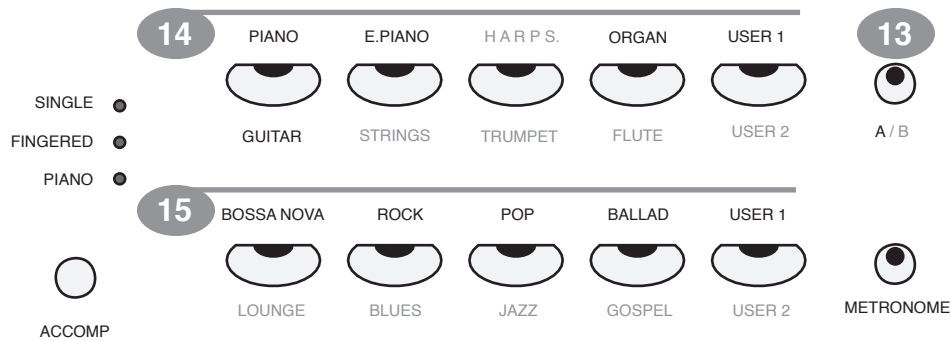

- 13. A/B BUTTON** - The five quick select voice and five quick select style buttons are each assigned to a line A and line B. Press the A/B button to alternate between the two selection lines. The indicator light will be lit when selection line B is active. Please see the quick select buttons below for more information.
- 14. QUICK SELECT VOICE** - There are ten instrument voices that can be selected quickly by pressing one of the five voice select buttons. These voices are assigned to line A and line B. Each of these selection lines consists of five voices. The voice name in the line A is printed above the voice select button and the voice name on line B is beneath the button. Press the A/B button to select the voice line of your choice. When the indicator light is lit the B line or bottom line is active. The selected voice name and its number will be shown on the display. Please see the Keyboard Voices section of this manual for more information.
- 15. QUICK SELECT STYLE BUTTONS** - There are ten Rhythm Styles that can be selected quickly by pressing one of the five Rhythm select buttons. These Rhythm Styles are assigned to line A and line B. Each of these selection lines consists of five rhythm styles. The Style name in the line A is printed above the Style select button and the Rhythm style name on line B is beneath the button. Press the A/B button to select the Rhythm Style line of your choice. When the indicator light is lit the B line or bottom line is active. The selected rhythm name and its number will be shown on the display. Please see the Rhythm Styles section of this manual for more information.

PANEL CONTROLS

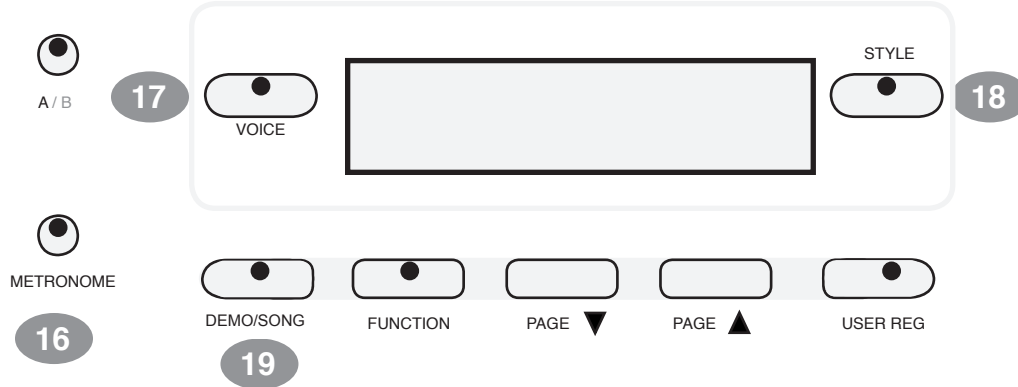

- 16. METRONOME** - Press the METRONOME button to engage the metronome. If the auto accompaniment is playing the metronome sound will replace the percussive rhythm sound immediately. If the auto accompaniment is not engaged, press the METRONOME button to start the metronome, and again to stop it. Time signature and volume of the metronome can be adjusted. Please see the Auto Accompaniment section of this manual for more information.
- 17. INSTRUMENT VOICE** - There are 128 GM (General MIDI) instrument voices, plus ten Asian folk instrument voices available on this piano. You can instantly select an instrument voice by pressing one of the voice select buttons. Or press the VOICE button to engage the voice selection mode. While its indicator light is lit, you can use the number pad to select all 138 voices listed in the back of the manual. Please see the Voice section of this manual for more information.
- 18. STYLE** - Press the STYLE button to engage the style selection mode. While its indicator light is lit, use the number pads to select a style. There is a complete list of all 100 rhythm accompaniment styles listed in the back of the manual. Please see the Rhythm section of this manual for more information.
- 19. DEMO/SONG** - This is a dual function button. The first pressing engages demonstration song mode with red indicator lighting. The second pressing engages the teaching mode with green indicator lighting.
The “music teacher” feature can be used as an aid to learn the 50 songs built into this piano. Please see the Training section of this manual for more information.
This piano has ten different demonstration songs. The demo mode will play back all ten demo songs or select the song individually.

PANEL CONTROLS

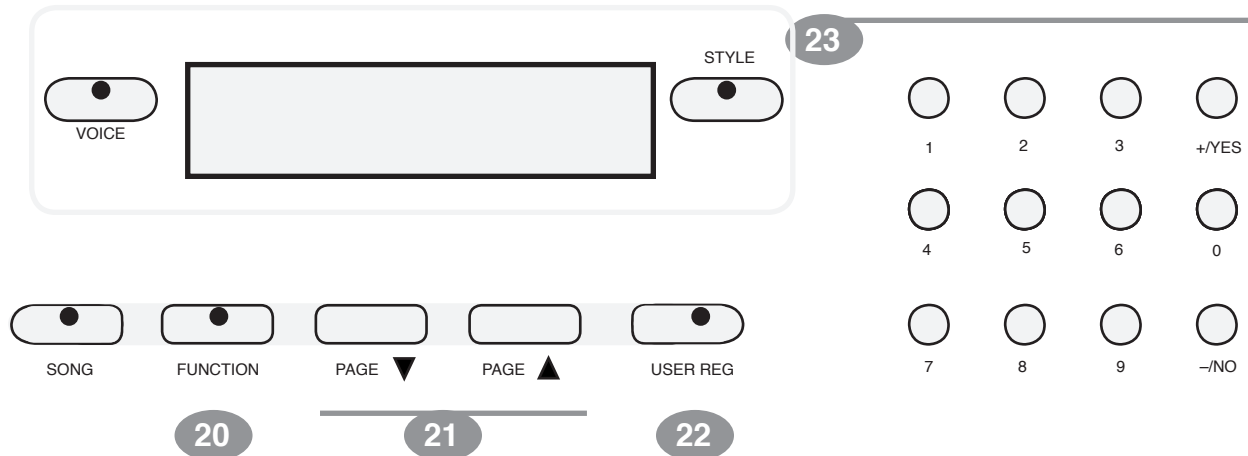

- 20. FUNCTION** - The FUNCTION button is used to access the function menu. The function menu can be used to adjust or change parameters of a number of setting. Reverb level, chorus level, touch, split point for voice, auto accompaniment split point, tuning, drum kit selection, the auto harmony type and local off are all set from the function menu. Please see the Function section of this manual for more information.
- 21. PAGE** - The PAGE buttons (up and down) are used to access the different menus in the Function feature. When the FUNCTION button has been pressed use the PAGE ▲ and PAGE ▼ to access the Function menu selections.
- 22. USER REG** - Registration is used to store keyboard settings. Press the USER REG button to engage the registration memory mode, the indicator will light up. Press one of the numeric buttons 1-9, the stored setting will be recalled instantly. Please see the Registration Memory section of the manual for more information.
- 23. NUMERIC PAD** - Use the +/YES, -/NO or the numeric pad to input numbers directly while using the voice, style or function settings. These buttons are also used to access or alter many of the function features or where ever numerical input is necessary.
- 24. TRANSPOSE** - The transpose feature can shift the pitch of the keyboard up or down in semitone intervals up to a maximum of 24 semitones. Press one of the TRANSPOSE buttons, the current transpose value will appear on the display. Use the TRANSPOSE + or TRANSPOSE – buttons to set the transpose value range from –12, one octave lower, to 12, one octave higher. Press the + and – value buttons simultaneously to recall the default value of 0. After three seconds the display will return to the

PANEL CONTROLS

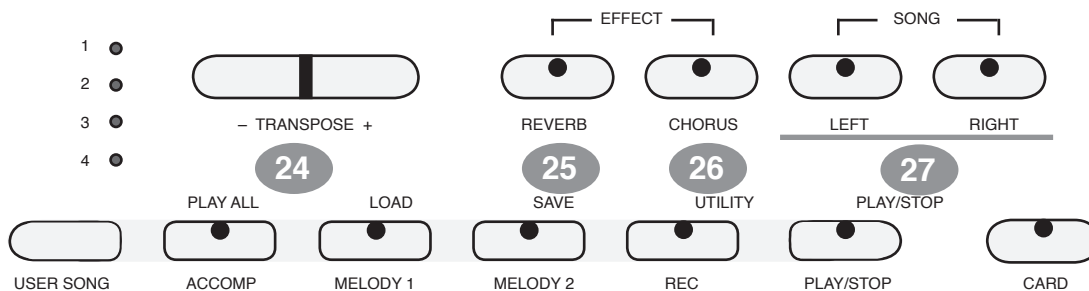

currently selected instrument voice. Transpose does not affect notes that are currently playing. Transpose does not affect the keyboard percussion.

25. **REVERB** - The reverb effect is engaged automatically when the power is turned on. Reverb simulates the effect of playing in a big room or hall where the sound reverberates off the walls and ceiling. Press the REVERB button to turn off the reverb effect. You can switch the reverb feature on and off by pressing the REVERB button. The reverb setting does not affect the auto accompaniment. Reverb depth can be changed in the function menu "Reverb Level". Please see the Function Section for more information.
26. **CHORUS** - The Chorus effect adds depth and spaciousness to the selected keyboard voice. Press the CHORUS button to engage the chorus effect and the indicator will light up. Press the button again to turn off the chorus effect. The chorus setting does not affect the auto accompaniment. Chorus depth can be changed in the function menu "Chorus Level". Please see the Function Section for more information.
27. **SONG LEFT , SONG RIGHT** - These buttons are used in conjunction with the SONG button. It allows the player to play along with the prerecorded traditional songs contain within this piano. The LEFT button will play the right hand of the selected song, so tht the user can practice the Left Hand portion of the song. The RIGHT button will play the Left Hand of the selected song, so that the user can practice the Right Hand portion of the song.

PANEL CONTROLS

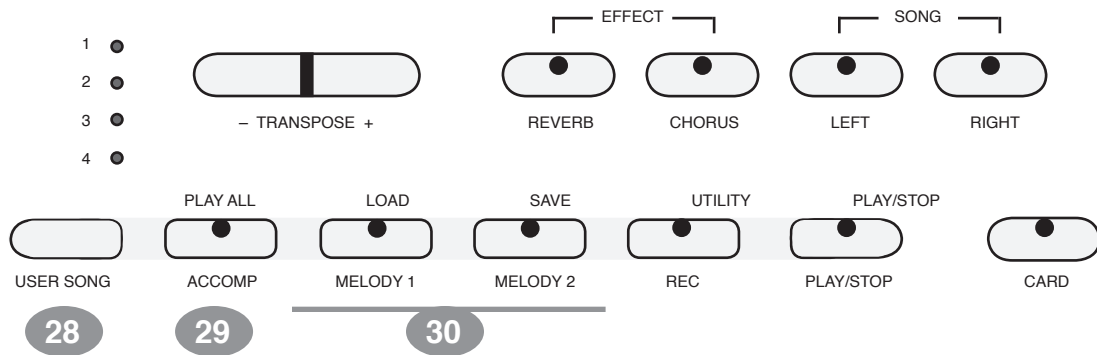

When engaging the LEFT and RIGHT buttons simultaneously only the accompaniment (if available) will be heard as the user should play both the Left and Right portions of the selected song. Please see the Play Along Song section of this manual for more information.

- 28. USER SONG** - The USER SONG button accesses one of the four available song settings for recording or playback. Use the +/YES, -/NO buttons to select the song you wish, if there is recorded information on any of the three tracks their indicator lights will light up. Please see the Record section of this manual for more information.
- 29. ACCOMP/PLAY ALL** - This is a dual function button for Record and Card mode.
 In the Record mode, this button is used to select the auto accompaniment track of a song for recording or playback.
 In the Card mode, press this button to play all MIDI files stored in the SD card.
 Please see the Record and Card sections of this manual for more information.
- 30. MELODY 1/LOAD , MELODY 2/SAVE** - These are dual function buttons for Record and Card mode. In the Record mode, there are two tracks for recording melody, which are assigned by the MELODY 1 and MELODY 2 buttons.
 In the Card mode, MELODY 1/LOAD button is used to load MIDI file from SD card; MELODY 2/SAVE button is used to save recorded song to SD card in MIDI file format.
 Please see the Record and SD Card sections of this manual for more information.

PANEL CONTROLS

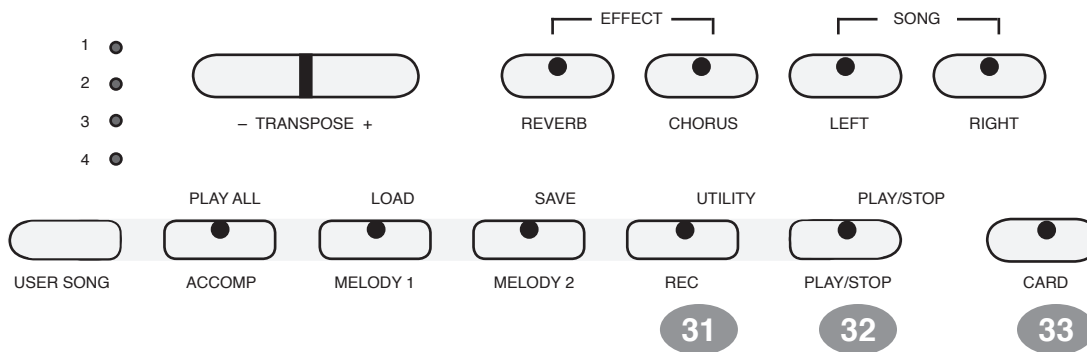

31. REC/UTILITY - This is a dual function button for Record and Card mode.

This unit is able to record four songs, each with a 3-track sequencer. It will record all note events and the accompaniment patterns exactly as they are performed. This recorded information is nonvolatile and therefore will not be lost when the power is turned off. To Record press and hold down the RECORD button then press the track button(s) you want to record in. Recording begins as soon as you start to play on any section of the keyboard. Press the RECORD button again to stop recording.

In the Card mode, it functions as utility access button which includes solo, mute and delete for a selected song in the card.. Please see the Record and SD Card sections of the manual for more information.

32. PLAY/STOP - This is a dual function button for Record and Card features. In the Record mode, press the PLAY/STOP button to hear selected tracks that you have recorded on. Press the PLAY/STOP button again to stop the playback.

In the Card mode, it functions as also play/stop switch for a selected song in the card.. Please see the Record and SD Card section of this manual for more information.

33. CARD - This piano is equipped with a mass storage device using popular SD card. User can read and play MIDI files in the card either in format 0 or format 1 and save the recorded music into the SD card as the MIDI file in format 1. User can also delete the MIDI files in SD card. Press the CARD button to engage the card mode and the indicator will light up. Press the button again to exit this mode.

Please see the Record and SD Card sections of this manual for more information.

DEMO

PLAYING THE DEMO SONGS - This piano has 13 different demonstration songs that are designed to showcase the different sampled voices that are available. The display will show the song number with a “d” prefix. When playing all the songs, “ALL” will appear on the display initially, and will change to the demo song number as it plays. After exiting the demonstration mode the display will revert to its initial data.

The DEMO/SONG button is a dual function button used for both Demo and play along song with variation of indicator color.



- 1. PLAY ALL DEMO SONGS** - Press the DEMO/SONG, the indicator lights up with red color. The first demo song will playback instantly. This unit has ten demo songs. All songs will play repeatedly until you press the DEMO/SONG button again to stop the demonstration and turns to the teaching song mode.

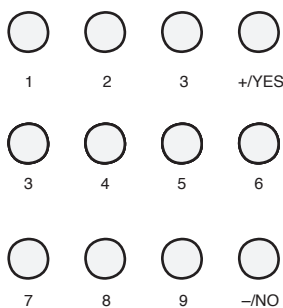
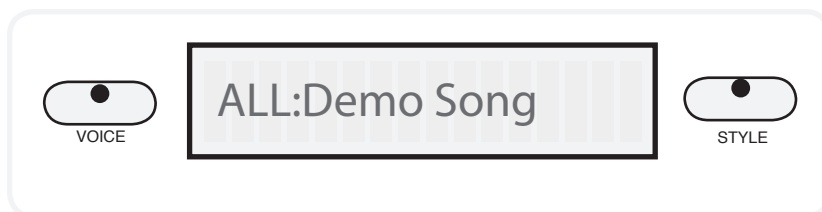

- 2. PLAY A SINGLE DEMO SONG** - Use the +/-YES or the -/NO buttons to change songs while the demo is playing, or enter a song number directly by using the numeric pad. Please note that two digits are required for selecting a song number, for example, to select song No. 9 enter “09”. The song will play repeatedly until you press the demo button again to stop.

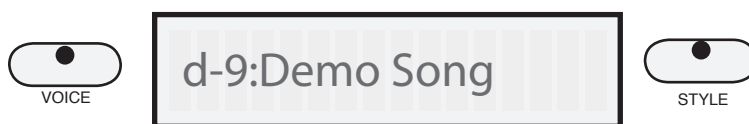

There are 50 songs for the musical training course that can also be played back for demonstration. Please see the Training section of this manual for more information.

KEYBOARD VOICES

VOICE SELECTION - There are 128 GM voices in 16 groups plus 10 Asian ethnic folk instrument voices. There is a complete list of all 138 voices in the back of the manual.

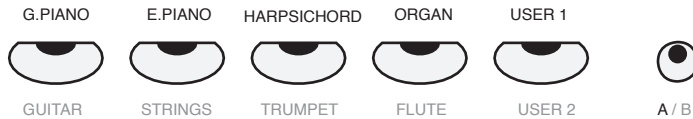

QUICK SELECT - There are ten voices that can be selected quickly by pressing one of the five voice select buttons. These voices are assigned to Instrument Line A and Instrument Line B. Each Line consists of five voices. The voice name in Line A is printed above the voice select button and the voice name in Line B is beneath the button.

1. Press the A/B button to select a voice kit. Selection of the Instrument Lines will alternate when the A/B button is pressed repeatedly. The indicator will be lit when Line B is selected.
2. Press the voice select button that corresponds to the desired voice in the Instrument Line you have selected. The voice name and its number will show on the display.



001:Grand Piano

SELECTING ONE OF THE 138 VOICES

1. If the Instrument Voice Button is not already lit press the VOICE button to engage the voice selection mode, the indicator will turn on.
2. Use the numeric pad or the +/YES, -/NO buttons to select a voice number.

Please note, when using the number pads, you must enter three digits to select a voice number from 001-138. For example, to select voice No. 2 you must enter "002". The voice name and its

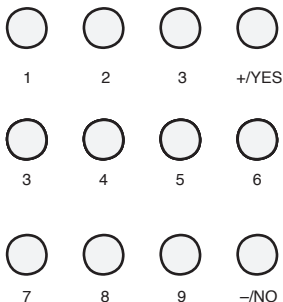

002:Bright Piano

KEYBOARD VOICES

number will show on the display. Please refer to the back of the manual for a list of all available voices.

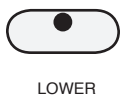
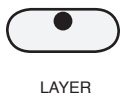

USER DEFINED QUICK SELECTION BUTTON - You can assign a favorite voice to the voice quick select button in the follow manner.

1. Press the voice USER button, USER 1 from Line A, or USER 2 from Line B to recall the current stored voice (User key LED On). The default user voices are USER 1= 012; Virvraphone, USER 2=092; Choir Pad.
2. If you want to assign your desired voice to USER button, press and hold down the User key for 2 or 3 seconds, User key LED will blink for the store mode
3. Select the desired voice by using the numeric pad or the +/YES, -/NO buttons. Please note: cannot use Voice quick select buttons.
4. Press the USER button again to store the voice. The indicator keeps On. The currently selected voice will be assigned to this button to be available for quick selection.
If another voice is selected while User Key is ON but the indicator does not blink for store mode, the new voice should become the active voice but not change the User Key assignment while User mode exits, the User indicator turns Off.
5. User Key assignments will be saved after Power Off.

LAYER (DUAL) VOICE - Layer, or dual, refers to an additional voice that is tone mixed with the selected keyboard voice. The assigned layer voice will be heard with the original voice when the layer feature is engaged.

1. Press the LAYER button, the currently assigned layer voice will show on the display, and the indicator will light up.
2. Use the +/YES, -/NO buttons or the numeric pad to select the desired voice. The display will show the layer voice number and name,
3. Press the LAYEL button a second time gain within 3 seconds and the current layer volume level will show on the display. Use the +/YES, -/NO buttons to adjust the layer volume level. Otherwise, this procedure will be skipped.
After three seconds the display will revert to the selected main voice.
4. Press the LAYER button again to turn the feature off.

LOWER VOICE - In the lpower, or split, mode the keyboard is divided into two sections. To the right of the Split Point the currently selected main voice, or the layer voice will sound. The keys to the left of the Split Point can play a different instrument voice.

KEYBOARD VOICES



FUNCTION

2. Use the +/YES, –/NO buttons or the numeric pad to select the desired voice. The display will show the lower voice number and name,
3. Press the SPLIT button a second time again within 3 seconds and the current lower volume level will show on the display. Use the +/YES, –/NO buttons to adjust the lower volume level. Otherwise, this procedure will be skipped.
After three seconds the display will revert to the selected main voice.
4. Press the SPLIT button again to turn the feature off.

ASSIGNING THE SPLIT POINT FOR VOICE - The keyboard is split into two sections at the split point. The default split point is the C3 key for voice. A different voice split point can be assigned in the Function menu “Split Point”. Please see the Function section of this manual for more information.

RHYTHM SECTION

RHYTHM STYLE SELECTION - This piano offers 100 rhythm styles and a variation of each style pattern to choose from. There is a complete list of all 100 styles in the back of the manual.

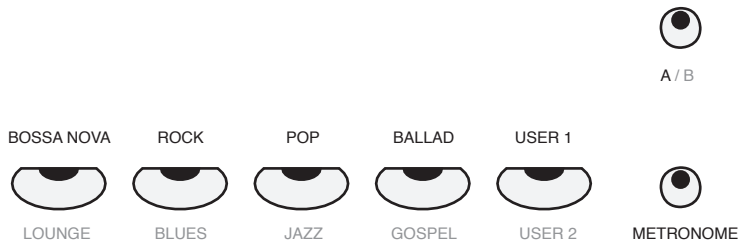

QUICK SELECT - There are ten styles that can be selected quickly by pressing one of the five style select buttons. These styles are assigned to Line A and Line B. Each Rhythm Style Line consists of five styles. The style name in Line A is printed above the style select button and the voice name in Line B is beneath the button.

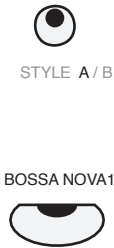

1. Press the A/B button to select a Line. Selection of the Lines will alternate when the A/B button is pressed repeatedly. The indicator will be lit when Line B is selected.
2. Press the style quick select button that corresponds to the desired style in the Line you have selected. The style name and its number will show on the display.

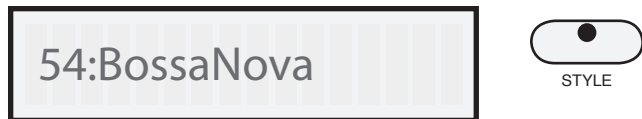

SELECTING ONE OF THE 100 STYLES

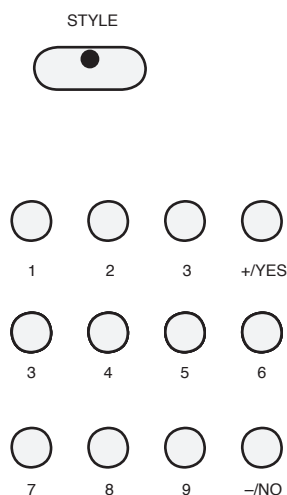

1. Press the STYLE button to engage the style selection mode, the indicator will light up.
2. Use the numeric pad or the +/YES, -/NO buttons to select a style number while the indicator is lit.
Please note, when using the number pads, you must enter two digits to select a style number from 00-99. For example, to select style No. 4 you must enter "04". The style name and its number will be shown on the display. Please refer to the back of the manual for a list of all available styles.

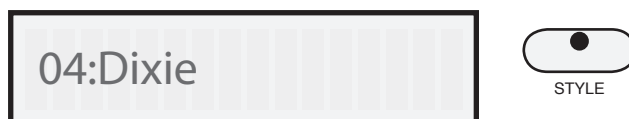

RHYTHM SECTION

USER DEFINED QUICK SELECTION BUTTON - You can assign a favorite rhythm style to the style quick select button in the following manner.



1. Press the style USER button, USER 1 from Line A, or USER 2 from Line B to recall the current stored style (User key LED On). The default user style are USER 1= 82; Kids 1, USER 2=32; Folk 2).
2. If you want to assign your desired style to USER button, press and hold down the User key for 2 or 3 seconds, User key LED will blink for the store mode.
3. Select the desired style by using the numeric pad or the +/YES, -/NO buttons. Please note: cannot use style quick select buttons.
4. Press the USER button again to store the style. The indicator keeps On. The currently selected style will be assigned to this button to be available for quick selection.
If another style is selected while User Key is ON but the indicator does not blink for store mode, the new voice should become the active voice but not change the User Key assignment while User mode exits, the User indicator turns Off.
5. User Key assignments will be saved after Power Off.

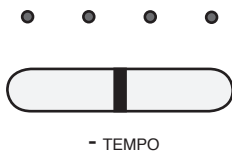

ADJUSTING THE TEMPO - There is a four-beat indicator above the TEMPO buttons that indicates the tempo and the beat for the accompaniment playing. Each style has its own preset tempo. The tempo can be adjusted before or during rhythm style play by pressing the either of the -TEMPO+ buttons. When you change the style before you play, the tempo will be set to that default value. If you change style during play, the tempo will keep its current value, press the -/+ TEMPO buttons simultaneously to set the tempo to the new styles default value.

RHYTHM SECTION

STARTING AND STOPPING THE RHYTHM STYLE - There are several ways to start and stop the rhythm style.



STRAIGHT START - The START/STOP button starts the selected rhythm style immediately with the percussive rhythm. Press the START/STOP button again to stop the accompaniment.



STARTING WITH AN INTRODUCTION - All of the 100 styles can be started with an appropriate introduction. As soon as you press the INTRO/ENDING button, the rhythm of the introduction will start followed by the main pattern. Press the START/STOP button to stop the accompaniment or the INTRO/ENDING button again to stop with an ending pattern.

Please note, if you want the selected rhythm style to be engaged again after the ending pattern has been completed, press the FILL IN button while the ending pattern is engaged.



SYNCHRONIZED START - Synchronized Start engages the accompaniment in the standby mode.

Press the SYNC START button, the beat indicator dots above the TEMPO buttons will blink at the current tempo, showing that the synchronized start mode is ready. The rhythm style will start as soon as you play in the auto accompaniment section of the keyboard. You may add an introduction by pressing the INTRO/ENDING button after pressing the SYNCH START button.

Press the START/STOP or the SYNCH START buttons to stop the accompaniment. If the SYNCH START button is used, the synchronized start mode will be on standby. Use the INTRO/ENDING button to stop with an ending pattern.

RHYTHM SECTION



VARIATION - To select the variation of the main patterns, press the VARIATION button. The indicator will light up. If you press the VARIATION button, then press the INTRO/ENDING button, the variation pattern will play after the introduction.



FILL - IN - The fill feature will insert a short rhythmic pattern of one to two measures in length, depending on the rhythm style selected and the variation. Holding down the FILL IN button will extend the fill indefinitely.



ASSIGNING THE SPLIT POINT FOR THE AUTO ACCOMPANIMENT

- The keyboard is split into two sections at the split point. The default split point is the G1 key for auto accompaniment. A different split point for the auto accompaniment can be assigned in the Function menu "Auto A.Split". Please see the Function section of this manual for more information.

AUTO ACCOMPANIMENT

AUTO ACCOMPANIMENT (AUTO BASS CHORD) - The rhythm styles have their own auto accompaniment, dedicated to that rhythm style. These auto accompaniment patterns create fully orchestrated rhythm, bass and chord progressions based on the chords that you play with your left hand. The selected rhythm style determines the characteristics of the auto accompaniment. The auto accompaniment section of the keyboard is assigned by the split point. The keys on the left of the split point are reserved for the auto accompaniment. The keys to the right are available for normal playing.

AUTO BASS CHORD FINGERING - This piano has three auto accompaniment fingering modes, single, fingered, and piano.

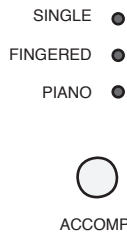

1. Press the ACCOMP button until the indicator light until the Fingering mode that you desire is selected.
2. Press the START/STOP or the SYNCH START buttons to start the rhythm style. Press the INTRO/ENDING button to start with an introduction.
3. Press the START/STOP or the SYNCH START buttons to stop the accompaniment, or press the INTRO/ENDING button to stop with an ending.

SINGLE (INTELLIGENT) MODE - Single fingering mode makes it simple to produce four types of orchestrated accompaniment chords using a minimum of fingers, (one, two, or three fingers at the most), while playing in the auto accompaniment section of the keyboard. In this mode, keys in the auto accompaniment section of the keyboard are used to produce major, seventh, minor, and minor-seventh chords. The auto accompaniment will start with the percussive rhythm as soon as a recognized chord is played. The accompaniment produced is perfectly matched to the selected rhythm style.

Major Chord: Press any key in the auto accompaniment section of the keyboard. The key you press determines the root note of the major chord.

Minor Chord: Press the root key and two keys to its left in the auto accompaniment section of the keyboard simultaneously.

Seventh Chord: Press the root key and one key to its left (7th key) in the auto accompaniment section of the keyboard simultaneously.

Minor-Seventh Chord: Press the root key and both the first and second keys to its left in the auto accompaniment section of the keyboard simultaneously.

AUTO ACCOMPANIMENT

- SINGLE ●
- FINGERED ●
- PIANO ●
- ACCOMP ○

FINGERED MODE - The fingered mode is ideal if you already know how to play chords on the keyboard. It allows you to play the chords in the auto accompaniment section of the keyboard that produce the selected auto accompaniment pattern.

Please note, if a chord played cannot be recognized (fingered beyond the table), the previous chord will keep playing. An unrecognized chord cannot start a bass chord in the straight start mode, and cannot start the auto accompaniment in the synchronized start mode. The “Fingering Guide” table below lists all of the 31 playable chords of this mode.

FINGERING GUIDE

Chord	Mark	Fingering
Major	M	1-3-5
Major sixth	M6	1-3-5-6
Major seventh	M7	1-3-(5)-7
Major seventh sharp eleventh	M7 #11	1-(2)-3-#4-(5)-7
Major add ninth	M 9	1-2-3-5
Major seventh ninth	M7 9	1-2-3-(5)-7
Major sixth add ninth	M6 9	1-2-3-(5)-6
Augmented	Aug	1-3-#5
Minor	m	1-b3-5
Minor sixth	m6	1-b3-5-6
Minor seventh	m7	1-b3-(5)-b7
Minor seventh flatten fifth	m7b5	1-b3-b5-b7
Minor add ninth	m 9	1-2-b3-5
Minor seventh add ninth	m7 9	1-2-b3-(5)-b7
Minor seventh add eleventh	m7 11	1-(2)-b3-4-5-(b7)
Minor major seventh	mM7	1-b3-(5)-7
Minor major seventh add ninth	mM7 9	1-2-b3-(5)-7
Diminished	Dim	1-b3-b5
Diminished seventh	Dim7	1-b3-b5-6
Seventh	7	1-3-(5)-b7
Seventh suspend fourth	7sus4	1-4-5-b7
Seventh add ninth	7 9	1-2-3-(5)-b7
Seventh sharp eleventh	7 #11	1-(2)-3#4-(5)-b7
Seventh thirteenth	7 13	1-3-(5)-6-b7
Seventh flatted fifth	7 b5	1-3-b5-b7
Seventh flatted ninth	7 b9	1-b2-3-(5)-b7
Seventh flatted thirteenth	7 b13	1-3-5-b6-b7
Seventh sharp ninth	7 #9	1-#2-3-(5)-b7
Major seventh augmented	M7aug	1-3-#5-7
Seventh augmented	7aug	1-3-#5-b7
Suspended fourth	Sus4	1-4-5

Please note, the notes listed in parentheses can be omitted.

The listed chord fingerings are all in root note position, other inversions can be used with the exception of:

1. The M6 chords are only recognized in root note position. All other inversions are interpreted as m7.
2. The 6 9 chords are only recognized in root note position. All other inversions are interpreted as minor chords.
3. The m6 chords are only recognized in root note position. All other inversions are interpreted as m7b5.
4. With aug and dim7 chords the lowest note played is assumed to be the root.
5. With 7#11 chords the lowest note played is assumed to be the root or b7.

AUTO ACCOMPANIMENT

AUTO BASS CHORD FINGERING continued

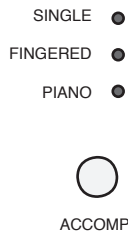

PIANO CHORD MODE - When the Piano fingering chord mode is engaged you may enter chords anywhere on the keyboard, and the auto accompaniment will make complete styled arrangements. You are not limited to the auto accompaniment section or the range of the split point. In this regard there is no keyboard split point function for this Piano Chord Mode.



MANUAL BASS CHORD - When engaged in the single or fingered mode, you may play individual keys in the auto accompaniment section of the keyboard. The voice on this section of the keyboard will be a layered bass and chord voice determined by the current style. This is a split voice mode, with the right hand playing the main voice.



AUTO HARMONY - With the harmony feature engaged, a single note on the right-hand section of the keyboard will sound with additional auto harmony notes. The note played in the right-hand section of the keyboard determines the root key of the harmony. If more than one note is played only the highest note will add harmony.

Please note, auto harmony is only available when the auto accompaniment is engaged.

Press the HARMONY button to turn the feature on and off. There are four harmony types that can be selected, duet, close harmony, open harmony, and octave. The harmony type selection is assigned in the Function menu. Use the “Harmony Type” menu to select the type of harmony. Please see the Function section for more information.

AUTO ACCOMPANIMENT

STARTING AND STOPPING THE AUTO ACCOMPANIMENT



STRAIGHT START - The START/STOP button starts the auto accompaniment as soon as you play a recognized chord in the auto accompaniment section of the keyboard. Press the START/STOP button again to stop the accompaniment.



STARTING WITH AN INTRODUCTION - All of the 100 styles can be started with an appropriate introduction. Press the INTRO/ENDING button, the introduction, followed by the main pattern will start as soon as you play a recognized chord in the auto accompaniment section of the keyboard.

Press the START/STOP button to stop the accompaniment or the INTRO/ENDING button again to stop with an ending pattern.

Please note, if you want the auto accompaniment to be engaged again after the ending pattern has been completed, press the FILL IN button while the ending pattern is playing.



SYNCHRONIZED START - Synchronized Start mode makes the auto accompaniment standby. The auto accompaniment will start as soon as you play a recognized chord in the auto accompaniment section of the keyboard.

1. Press the SYNC START button, the beat indicator dots above the TEMPO buttons will blink at the current tempo, indicating that the synchronized start mode is ready.
Please Note: You may add an introduction by pressing the INTRO/ENDING button after pressing the SYNCH START button.
2. Play a recognized chord in the Auto Accompaniment Section of the piano.
If the auto accompaniment is off, (the auto accompaniment indicator is off), only the percussive rhythm will play.
3. Press the START/STOP or the SYNCH START buttons to stop the accompaniment.
If the SYNCH START button is used, the synchronized start mode will be on standby. Use the INTRO/ENDING button to stop with an ending pattern.

AUTO ACCOMPANIMENT



VARIATION - To select the variation of the main patterns, press the VARIATION button. The indicator will light up. If you press the VARIATION button, then press the INTRO/ENDING button, the variation pattern will play after the introduction.



FILL-IN - The fill feature will insert a short rhythmic pattern of one to two measures in length, depending on the rhythm style selected and the variation. Holding down the FILL IN button will extend the fill indefinitely.



ASSIGNING THE SPLIT POINT FOR THE AUTO ACCOMPANIMENT - The keyboard is split into two sections at the default split point G1 key for auto accompaniment. A different split point for the auto accompaniment can be assigned in the Function menu "Auto A.Split". Please see the Function section of this manual for more information.



METRONOME -

If the auto accompaniment is playing the metronome sound will replace the percussive rhythm sound immediately. If the auto accompaniment is not engaged, press the METRONOME button to start the metronome, and again to stop it.

1. Press the METRONOME button to start the metronome. Its indicator will light up and the "Metronome" menu will appear on the display..



Metronome 3/4

2. Use the +/YES or the -/NO to choose the meter to choose the meter 2/4, 3/4, 4/4, 5/4, 6/4 or 12/8 within 3 seconds after the metronome has been engaged . Then, the display will revert to the selected Voice.
3. Use the ACCOMP VOLUME slider to adjust the metronome volume and use the TEMPO +/- buttons to change the tempo of the metronome.

USB FLASH DRIVE

This piano is equipped with a mass storage device using popular USB Flash memory drive.

User can read and play MIDI files in the memory either in format 0 or format 1 and save the recorded music into the USB flash memory drive as the MIDI file in format 1. User can also delete the MIDI files in the memory.

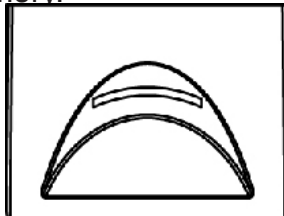

Note: Directory architecture in the USB flash drive cannot be supported, you can only operate the files under the root directory in the USB memory. The Max number of file supported is 128 and the Max size of MIDI file cannot be larger than 128Kbytes.

Insert Memory Card - Insert USB Flash drive to the slot of the USB Flash drive holder.

Take Out The USB Flash Drive - Pull up the USB Flash drive.

Note: Don't take out the USB Flash drive or turn off the power switch when the USB Flash drive is under reading or saving process to avoid any damage

Enter the Card Mode

1. Press the USB MEMORY button to engage USB Flash drive operation mode and the indicator is lit. The main page of USB Memory mode is:

USB MEMORY

Press the USB MEMORY button again to exit this mode and return to the normal piano mode, the indicator turns off.

Note: Can't enter the USB Flash drive mode directly when record or play along song mode is engaged.

2. The record function buttons are dual function buttons. Please follow the nomenclature above buttons in the card mode.

USB FLASH DRIVE

3. If no USB Flash drive inserted, or the USB Flash drive is not at proper location, or the USB Flash drive has been damaged, you can't step to the next operation. The screen displays "No USB Drive". After about 3 seconds, it returns to normal piano mode, the card indicator turns off.

Save the Recorded Song into the Card

1. Press the saving button, the indicator lights up. If there is no unsaved song, the display will show "No new song". After about 3 seconds, it will exit the saving operation and return to main page.



No new song

2. If an unsaved song does exist, one of the song indicators will blink referring the song to be saved to the card. The display will prompt "Save it?"



Save it?

3. If you don't want to save this song, press -/NO button. If there are more than one unsaved songs exist, the next song indicator will blink and the display will prompt "Save it?" again. If keep on pressing -/NO button to give up saving operation, then it will exit the saving operation after inquiring all the songs.

4. If you really want to save a song, press +/YES button. The file name of the song to be saved to the USB Memory will appear in the display. This file name is automatically generated.



Song 003 88%

When the saving starts, the completion percentage of the saving will be shown in the display.

5. After finish the saving for this song, OK will appear in the display for about 3 seconds. If there is another unsaved song exists, the procedure 2-4 will repeat, After all completed, it will automatically exit the saving operation and return to the main page. The saving indicator turns off.

USB FLASH DRIVE

6. If the space of the card is full, "Memory is full!" will appear in the display for 3 seconds. Then, it will exit the saving operation and turn back to the main page. And the saving indicator turns off.



Memory is full!

7. Press the button "0" to exit the saving operation and return to the main page. The save indicator turns off.

Note: although the recorded songs have been saved into the USB Flash drive, they are still kept in built-in memory of the piano. You will not be asked to save them into the USB Flash drive. If you changed them in record mode, you will be inquired to save them into the USB Flash drive.

USB FLASH DRIVE

Play All MIDI Files in the Card

This feature plays all MIDI files in the USB Flash drive one by one.

1. Press the PLAY ALL button and its indicator is lit.

Before playing back, the file in the card will be loaded into the piano. Because the file loaded shares the same built-in memory of recorded song in the piano, if you have your song recorded, this loading operation will erase it. When songs recorded but unsaved to USB Flash drive really exist, the display will remind you “Save your song?” for safety.

Save your song?

2. If you want to save it, press the +/YES button and turns to save page mentioned above automatically. When saving process is over, and then returns to all playing page. If you don't need to save, press the -/NO button and loading goes on. If there is no unsaved song, this inquiring will skip and the loading process keeps on automatically.

3. After the step above finished or skipped, the first file name appears in the display. The display can show the file name with 8 letters in maximum. If the file name consists of more than 8 letters, the display presents the first 6 letters and the 7th letter appears as “^” to indicate that the rest letters are eliminated. The 8th letter is a number. It refers to number of file which has the same first 8 letters and the file name is more than 8 letters. For example, “Dreaming Melody” is displayed as “Dreami^1”, “Dreaming song” is displayed as “Dreami^2”.

Dreami~1

Note: If there is no MIDI file in the USB Flash drive, “No music file” will appear in the display for about 3 seconds. Then it returns to the main page.

No MIDI file

4. When loading starts, the completion percentage of loading will be shown in the display.

Dreami~1 88%

USB FLASH DRIVE

5. The file will automatically play after being loaded. The PLAY/STOP indicator lights up. The percentage of played parts of the file will appear in the display.

6. After a file playing back finished, the step 2-3 mentioned above will be automatically carried on. While the file is playing you can press the +/YES or -/NO button to select other file.

Note: If the channel number of the MIDI file is more than 16, which exceeds the capability of the piano, the file can not be loaded. “Too many Channels” will appear on the display. The next file will be loaded and played automatically.



Too many chnls!

Note: The Maximun size of individual file loadable is 128K, If the size is larger than 128K, “Too large file” will appear on the display. The next file will be loaded and played automatically.



Too large file!

6. Press the PLAY/STOP or press Play All button again to stop all playing. The indicator turns off and returns to the main page. Or, when all files in the USB Falsh drive are played, it will automatically stop and return to the main page.

The solo, mute, save operation could be avalaible only after Play All mode exited.

Note: Lyrics display feature is not supported.

USB FLASH DRIVE

Load and Play a File

You should load the file into the piano at first to play single file in USB Flash drive, or to enable solo, mute feature.

1. Press the LOAD button, the button indicator lights up.

The first file name appears in the display.

The display can show the file name with 8 letters in maximum. If the file name consists of more than 8 letters, the display presents the first 6 letters and the 7th letter appears as “^” to indicate that the rest letters are eliminated. The 8th letter is a number. It refers to number of file which has the same first 8 letters and the file name is more than 8 letters.



Dreami~1

If there is no MIDI file in the card, “No music file” will appear in the display for about 3 seconds. Then it returns to the main page.



No music file

2. Use +/YES or -/NO button to select file you desire.

3. Press the LOAD button again to confirm your selection.

Because the file loaded shares the same built-in memory of recorded song in the piano, if you have your song recorded, this loading operation will erase it. When songs recorded but not saved to card really exist, the display will remind you “Save your song?” for safety.



Save your song?

If you want to save it, press the +/YES button and turns to save page mentioned above automatically while LOAD indicator turns off. When the saving finished, it'll back to loading page. If you don't need to save, press the -/NO button and loading goes on. If there is no unsaved song detected, this operation will be skipped.

4. When loading starts, the percentage of completed loading will be shown in the display.



Dreami~1 88%

USB FLASH DRIVE

Note: The Maximum size of individual file loadable is 128K, If the size is larger than 128K, “Too large file” will appear on the display. Then, it’ll turn to the main page.

Too large file

Note: If the channel number of the MIDI file is more than 16, which exceeds the capability of the piano, the file can not be loaded. “Too many Channels” will appear on the display. Then, it’ll turn to the main page.

Too many channels

5. After loading 100% completed, “OK” appears on the display then it turns to the main page. LOAD indicator turns off.

6. Press the PLAY/STOP button to play the file. The PLAY/STOP indicator lights up. The percentage of played parts of the file will appear in the display. Press the PLAY/STOP button again to stop playing, the indicator turns off.

Note: If press the PLAY/STOP button while no file has been loaded, “No file loaded” will appear on the display.

No file loaded

7. You can play keyboard while a file is playing. You can also choose voice while playing keyboard. If your playing over laps a voice of file playing back, you may mute the first channel as described in the next chapter of the manual, and play your own melody to replace that in the file.

USB FLASH DRIVE

Note: You can't play with layer or split mode. If the layer or split mode has been engaged when enter into the card operation mode, they will automatically be disabled.

Note: Lyrics display feature is not supported.

Solo a Channel The MIDI file may contain several channels; each channel delivers a musical instrument sound simultaneously with other channels. If you want, you can choose a channel to Solo. This can also used as the preparation for muting a channel – determining which channel to be muted in the mute mode.



1. Press the UTILITY button after loading a file, the indicator lights on. There are three utilities can be selected. They are Solo, Mute and Delete. Use +/YES button or -/NO button to select Solo.



Note: If there is no file loaded, “No file loaded” will appear on the display. Then it returns to the main page.

2. Press the UTILITY button again to confirm your selection. The first channel number will appear on the display. Use +/YES button or -/NO button to select a channel to solo.

Note: If the file contains less than 16 channels, the display shows only the channel number existing.

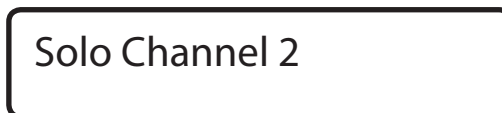

3. Press the PLAY/STOP button to play the solo channel selected with its indicator lighting up. Press the PLAY/STOP button again to stop playing, the indicator turns off. The playing will automatically stop after all contents in this channel played. Then it returns to the Solo page and you may continue to select channel.

4. Press button 0 in the number pad area to exit the utility mode and return to the main page.

USB FLASH DRIVE

Mute a Channel

The MIDI file may contain several channels; each channel delivers a musical instrument sound simultaneously with other channels. If you want, you can mute a channel and play by yourself on the keyboard.

1. Press the UTILITY button after loading a file, the indicator lights on. There are three utilities can be selected. Use +/YES button or -/NO button to select Mute.



Mute

2. Press the UTILITY button again to confirm your selection. The first channel number will appear on the display. Use +/YES button or -/NO button to select a channel to mute.

Note: If the file contains less than 16 channels, the display shows only the channel number existing.



Mute Channel 2

Note: If there is no file loaded, “No file loaded” will appear on the display. Then it returns to the main page.

3. Press the PLAY/STOP button to play all channels except the mute channel selected with its indicator lighting up. Press the PLAY/STOP button again to stop playing, the indicator turns off. The playing will automatically stop after all contents in this channel played. Then it returns to the Solo page and you may continue to select channel.

4. You may perform on the keyboard with music file playing as accompaniment. Normally, the voice in your playing is the same as muted voice; all indicators of the voice quick select buttons will be lit off. You may choose your own voice by voice quick select buttons; press the same quick select button to recover the original voice of the mute channel.

5. Press button 0 in the number pad area to exit the utility mode and return to the main page.

USB FLASH DRIVE

Delete File

This operat should be conducted when the display in the USB Falsh drive main page.

1. Press the UTILITY button, the indicator lights on. Use +/YES button or -/NO button to select Delete.

Delete

2. Press the UTILITY button again to confirm your selection.

3.The first file name will appear on the display. Use +/YES button or -/NO button to select a file to delete.

Del Song012

Note: If there is no MIDI file in the card, “No music file” will appear in the display for about 3 seconds. Then it returns to the main page.

No MIDI file

4. Press the UTILITY button again to enter the file selected.

5. The display will remind you “Save your song?” for safety.

Are you sure?

Press the +/YES button to carry on the deleting or press the -/NO button to ignore the delete then return to the main page.

6. When the delete is finished, “OK” will appear on the display then return to the main page.

OK!

7.Press button 0 in the number pad area to exit the utility mode and return to the main page.

FUNCTION

The Function mode is used to set up or to adjust various parameters related to the operation of this keyboard. With the FUNCTION button engaged you may access the menu for the Equalization, Reverb type & level, Chorus type & level, Touch sensitivity, Lower Split point for voice, Split point for auto accompaniment, tuning, the Drum kit selection, Harmony type selection and local off feature switch.

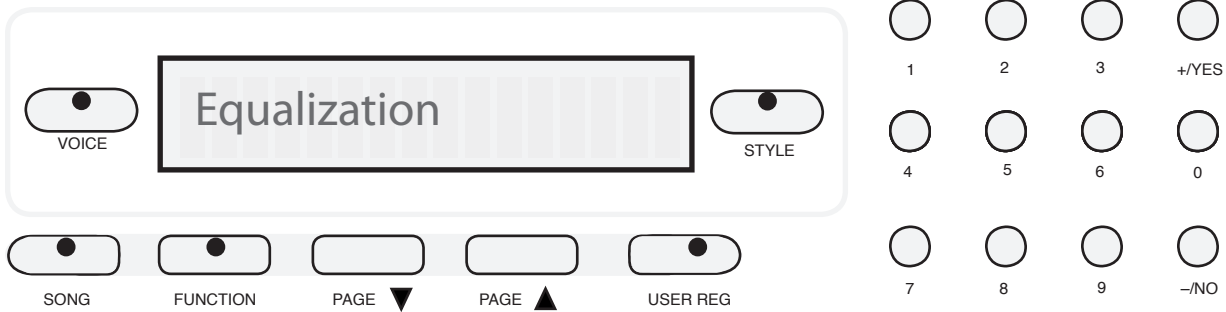

USING THE FUNCTION MENU

- 

1. Press the FUNCTION button. The first menu item that can be manipulated will appear on the display.
- 

2. Press the PAGE▼ or the PAGE▲ buttons until the menu you wish to access appears on the display screen.
- 

3. Press the +/YES button to show the current parameter for your selected function.
- 

4. Use the number pad or the +/YES, -/NO buttons to set a new parameter.
Note: Pressing the +/YES and the -/NO buttons simultaneously will recall the default setting.
5. To exit the setup mode press any control button except the +/YES, -/NO or the FUNCTION button.

FUNCTION

DRUM KIT SELECTION (KEYBOARD PERCUSSION) - When keyboard percussion has been engaged, the entire keyboard will play the percussion voices from the selected Drum kit. There are ten drum kits, based on the Standard Kit, that can be assigned. Kit 10 is a sound effects kit. Please see the “Drum List” at the back of the manual for a complete listing.



Drum Kit

1. Press the FUNCTION button, then the +/YES button to confirm.
2. Press the PAGE ▼ or the PAGE ▲ buttons until the “Drum Kit” menu appears.
3. Press the +/YES button to enter the Keyboard Percussion mode.
4. Use the +/YES, -/NO buttons to select a drum kit 01 to 10.



KYBD PERC.01

Note: Pressing the -/NO button when KYBD PERC.01 is selected will return the piano to regular Voice mode, and display the last selected voice. Pressing the -/NO button when KYBD PERC.10 is selected will return the piano to regular Voice mode, and display “Percussion OFF” until another kit is selected.

5. To exit the setup mode press any control button except the +/YES, -/NO or the FUNCTION button. If a kit is selected, the display will show “Percussion ON”. Use the +/YES, -/NO buttons to select a drum kit 01 to 10.
6. To quickly exit the keyboard percussion mode, press any one of the quick select voice key.

REVERB LEVEL SETTING - Reverb simulates the effect of playing in a big room or hall where the sound reverberates off the walls and ceiling. The reverb effect is engaged automatically when the power is turned on. You can switch the reverb feature on and off by pressing the REVERB button. Select the level of reverb from the Function menu.



Reverb Level

1. Press the FUNCTION button.
2. Press the PAGE ▼ or the PAGE ▲ buttons until the “Reverb Level” menu appears.
3. Press the +/YES button and the current reverb level will be shown.
4. Use the +/YES button to increase the reverb level or the -/NO buttons to decrease the level. The number pad can also be used

FUNCTION



to directly enter a value ranged from 01-127. Press the +/YES, -/NO buttons simultaneously to recover the default setting.

5. To exit the setup mode press any control button except the +/YES, -/NO or the FUNCTION button.

CHORUS LEVEL SETTING - The Chorus effect enriches your selected instrument voice by adding depth and texture.

Press the CHORUS button to engage the chorus effect, the indicator will light up. Adjust the level of chorus in the Function menu.

Chorus Level

1. Press the FUNCTION button.
2. Press the PAGE ▼ or the PAGE ▲ buttons until the “Chorus Level” menu appears.
3. Press the +/YES button to confirm your selection and the current Chorus level will be shown.
4. Use the +/YES to increase the chorus level or the -/NO buttons to decrease the level. The number pad can also be used to directly enter a value ranged from 01-127. Press the +/YES, -/NO buttons simultaneously to recover the default setting of 08.
5. To exit the setup mode press any control button except the +/YES, -/NO or the FUNCTION button.

TOUCH RESPONSE SETTING - The piano offers four types of keyboard touch sensitivity settings, soft, normal, hard, and fixed. These are also known as velocity settings and are designed to suit your style of playing. The normal setting is selected automatically when the piano is turned on. The touch response can be changed with the function feature.

Soft is the most sensitive keyboard response which permits maximum sound levels with a light touch.

Normal is an intermediate response suitable for most styles of music. Normal is the default setting.

Hard is a less sensitive keyboard response which requires a heavier touch to obtain maximum sound levels.

Fixed does not offer any touch sensitivity. Each key plays at full volume no matter how hard the piano key is hit.

It is commonly used on Harpsichord and Organ voices.

Touch

1. Press the FUNCTION button.
2. Press the PAGE ▼ or the PAGE ▲ buttons until the “Touch” menu appears.
3. Press the +/YES button to confirm your selection. The current touch response setting will be shown.

FUNCTION

4. Use the +/YES, -/NO buttons to select a touch response.
5. To exit the setup mode press any control button except the +/YES, -/NO or the FUNCTION button.

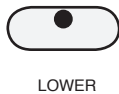

CHANGING THE SPLIT POINT FOR LOWER VOICE - When the lower mode isn't engaged the keyboard is divided into two parts at the split point. In the right hand section the original or Upper voice will sound. In the left hand section a new instrument voice can be assigned, the lower voice. The split point for the Lower section can be changed in the Function feature.

Split Point

1. Press the FUNCTION button.
2. Press the PAGE▼ or the PAGE▲ buttons until the "Split Point" menu appears.
3. Press the +/YES button to confirm your selection and the current voice split point will be shown.
4. Use the +/YES button to shift the split point up the keyboard, to the right, and the -/NO button to shift the split point down the keyboard, to the left. The number pad can also be used to enter the split point directly (by key number) from G2–C7. Press the +/YES, -/NO buttons simultaneously to recover the default setting of C3.
5. To exit the setup mode press any control button except the +/YES, -/NO or the FUNCTION button.

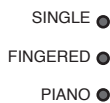

CHANGING THE SPLIT POINT FOR AUTO ACCOMPANIMENT - The split point that divides the keyboard can also be changed in the function menu.

Auto A.Split

1. Press the FUNCTION button.
2. Press the PAGE▼ or the PAGE▲ buttons until the "Auto A.Split" menu appears.
3. Press the +/YES button to confirm your selection and the current auto accompaniment split point will be shown.
4. Use the +/YES button to shift the split point up the keyboard, to the right, and the -/NO button to shift the split point down the

FUNCTION



HARMONY

AUTO HARMONY TYPE SELECTING - When the HARMONY button is engaged, a single note on the right-hand section of the keyboard will sound with additional auto harmony notes, when the auto accompaniment is engaged. There are four types of harmony that can be selected.

Duet adds a harmonizing note sounding below the single right hand note that you supply when the chord accompaniment is playing.

Close harmony adds two harmonizing notes sounding below the single right hand melody note that you supply, when the chord accompaniment is playing.

Open harmony

Octave add a note one octave below the note you play in the right hand section of the keyboard when the chord accompaniment is playing.

1. Press the FUNCTION button, then the +/YES button to confirm.
2. Press the PAGE ▼ or the PAGE ▲ buttons until the “Harmony Type” menu appears.
3. Press the +/YES button to confirm your selection. The current harmony type will be shown.
4. Use the +/YES or -/NO buttons to select a harmony type.
5. To exit the setup mode press any control button except the +/YES, -/NO or the FUNCTION button.

Harmony Type

MASTER TUNE - The pitch of this piano is very accurate and stable, it is automatically set to standard A440 pitch when the piano is turned on. The tuning feature makes it possible to tune the pitch of the instrument in fine intervals. If necessary, you can alter the piano pitch. Tuning can be accomplished over -50 to +50 semitone steps, or cents.

Master Tune

1. Press the FUNCTION button.
2. Press the PAGE ▲ or the PAGE ▼ buttons until the “Master Tune” menu appears.
3. Press the +/YES button the tuning value will be shown.
4. Use the +/YES button to increase the value or the -/NO buttons to decrease the value. Press the +/YES, -/NO buttons simultaneously to recover the default setting of 00.
5. To exit the setup mode press any control button except the +/YES, -/NO or the FUNCTION button.

FUNCTION

EQUALIZATION - The Equalization function will adjust the global “tone” of the internal sound output of the piano.

Equalization

1. Press the FUNCTION button.
2. Press the PAGE ▲ or the PAGE ▼ buttons until the “Equalization” menu appears.
3. Press the +/YES button the current EQ type will be shown.
4. Use the +/YES or the -/NO buttons to select EQ type you desire. The available EQ types are listed below:
 1. Piano
 2. Bright
 3. Bright Middle
 4. Middle boost
 5. Bass Middle
 6. Bass Boost
 7. Flat
 8. Classical
 9. Jazz
 10. Pop
 11. Rock
5. To exit the setup mode press any control button except the +/YES, -/NO or the FUNCTION button.

REVERB TYPE - There are 10 reverb types available to choose.

Reverb Type

1. Press the FUNCTION button.
2. Press the PAGE ▲ or the PAGE ▼ buttons until the “Reverb Type” menu appears.
3. Press the +/YES button the current reverb type will be shown.
4. Press the +/YES or the -/NO buttons to select type listed below
 1. Small Hall
 2. large Hall
 3. Plate reverb
 4. Church
 5. Cathedral
 6. Gated Reverb
 7. Echo
 8. 3/4 Echo
 9. 4/4 Echo
 10. Triplet Echo
5. To exit the setup mode press any control button except the +/YES, -/NO or the FUNCTION button.

CHORUS TYPE - There are 8 Chorus types available to choose.

Chorus Type

1. Press the FUNCTION button.
2. Press the PAGE ▲ or the PAGE ▼ buttons until the “Chorus Type” menu appears.
3. Press the +/YES button the current chorus type will be shown.
4. Press the +/YES or the -/NO buttons to select type listed below:
 1. Chorus Deep
 2. Resonant Chorus
 3. Flange
 4. Flange Deep
 5. Phaser
 6. Tremolo
 7. Tremolo Medium
 8. Tremolo Fast
5. To exit the setup mode press any control button except the +/YES

FUNCTION

VOCAL GRADING - After performance of the play-along song, you can hear vocal grading. You could disable this feature.



Vocal Grade

1. Press the FUNCTION button.
2. Press the PAGE ▲ or the PAGE ▼ buttons until the “Vocal Grade” menu appears.
3. Press the +/YES button the current status will be shown.
4. Press the +/YES button to set Vocal grading ON, or the –/NO buttons to set it Off
5. To exit the setup mode press any control button except the +/YES, –/NO or the FUNCTION button.

LOCAL - Normally, playing on the keyboard generates sound while sends MIDI message via MIDI connector or USB. This mode is called Local On. If you desire, you could mute the piano but simply send out the MIDI message. This mode is Local Off.



Local

1. Press the FUNCTION button.
2. Press the PAGE ▲ or the PAGE ▼ buttons until the “Local” menu appears.
3. Press the +/YES button the current status will be shown.
4. Press the +/YES button to set Local ON, or the –/NO buttons to set it Off
5. To exit the setup mode press any control button except the +/YES, –/NO or the FUNCTION button.

FACTORY SETTING - This function will reset the piano with factory default setting..



Reset

1. Press the FUNCTION button.
2. Press the PAGE ▲ or the PAGE ▼ buttons until the “Reset” menu appears.
3. Press the +/YES button to recover the factory setting.
4. To exit the setup mode press any control button except the +/YES, –/NO or the FUNCTION button.

RECORD

This piano is equipped with a real time recorder, able to store four songs, each with a 3-track sequencer. It will record all note events and the accompaniment as they are performed. This recorded information is nonvolatile and therefore will not be lost when the power is turned off. All the tracks can playback separately or together as a complete song.



RECORDING -

- 1. Prepare** - Prepare to record by setting the voice, style, tempo and reverb level and other parameters as desired.

These settings can be stored into a registration memory for easy recall, please see the registration memory section for more information.



- 1 ●
- 2 ●
- 3 ●
- 4 ●

- 2. Select a Song** - Press the USER SONG button, and use the +/YES, -/NO buttons to select a song, the display will show the song number selected. This is where the recorded information will be stored.

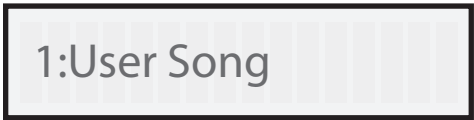

- 3. Select a track - Melody** will record, all notes.

There are two tracks available for recording the melody, these are assigned by pressing the MELODY 1 or the MELODY 2 button.

Auto Accompaniment will record all the auto accompaniment events just as they are played.

The ACCOMP track button will select the accompaniment track.

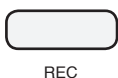

Press and hold down the REC button, then press the track button that you want to record in. The corresponding track indicator will blink and immediately erase the existing recording in this track. The four dots of the beat indicator will blink with the current tempo, to show that the recorder is on standby.

If you already have a recorded track(s) in the selected song, that indicator will also be lit and the recorded music will play, as a reference for you while you record the new track. If you do not wish for previously recorded tracks to play while you are recording, press the corresponding track button to turn the indicator light off.

- 4. Metronome** - Press the METRONOME button to enable the metronome as a reference when recording only melody track. The metronome sound will not be recorded.

Note: If you use the metronome when recording the accompaniment track, the metronome will play in place of the drum part of the auto accompaniment.

RECORD

RECORDING (continued)

4. **Record** - Your performance can be recorded in the following ways:



Record Melody Track Only

If the MELODY 1 or MELODY 2 buttons are selected the recording will begin as soon as you play the keyboard.

Please Note: It is suggested to turn off the fingering mode when recording on a melody track alone. When the fingering mode is set to Fingered or Single, the auto accompaniment section of the keyboard will not be recorded, although the notes are sounding.



Record Auto Accompaniment Track Only

With the Auto Accompaniment ACCOMP engaged recording will start as soon as a chord is played on the auto accompaniment section of the keyboard.

Please note, notes played on the Melody section of the keyboard will not be recorded in the auto accompaniment track. If the auto accompaniment is off, only the percussive rhythm will be recorded in the ACCOMP track.

An unrecognized chord in the fingered mode cannot start the recording.

Record the Auto Accompaniment and a Melody Track

If you want to record a melody and the accompaniment at the same time, Press a MELODY track button, then the ACCOMP track button and both indicators will blink in the standby mode. Recording begins as soon as you start to play on any section of the keyboard.



Please Note: the contents in a track will be erased as soon you start to record on the selected track.

It will be replaced by the new data that the user is recording.

5. **Stop Recording** - Press the START/STOP button, the PLAY/STOP button or the REC button to stop recording.

Or when the accompaniment track is being recorded, press the INTRO/ENDING button to stop the recording with an ending pattern in the accompaniment track.



Please Note: When the record memory is full, recording will stop automatically and “End” will appear on the display screen.

RECORD

PLAYBACK - To listen to the recorded passage:

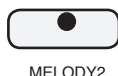

1. Press the USER SONG button and select the song you want to play back, using the +/YES, -/NO buttons. The display will show the song number.

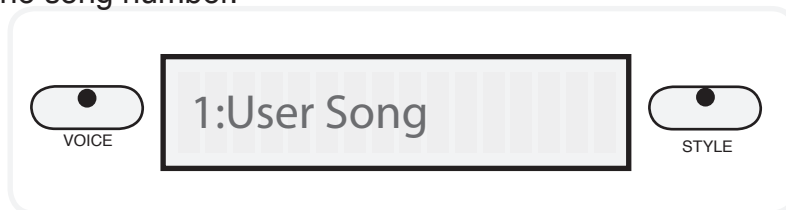

2. After you have selected your desired User Song, the LED indicators of those recorded channel tracks will be engaged. If you do not wish to hear a specific track, press the corresponding track button to turn that track off. Its LED indicator will turn off.

3. Press the PLAY/STOP button to hear the recorded track(s). The dots of the beat indicator will flash. You can change the tempo by pressing the +TEMPO- buttons. You may also play on the keyboard while the recording is playing back.

4. Press the PLAY/STOP button again to stop the playback. Playback will stop automatically when the recording reaches its end.

5. Press the USER SONG button again to exit the Record Mode, the display screen will revert to the current voice selected.

Note: The melody track can record layer or lower performance. But cannot record layer and lower at the same time. In the record mode, when layer or lower mode is triggered, then press another mode button, the mode will be toggled to new one. If both layer and lower mode are engaged before entering record, when enter the record mode, only layer mode remains and the lower will be disabled automatically.

REGISTRATION MEMORY

Registration Memory can recall particular settings of style, voice, chord and other parameters or features you have engaged. This piano has nine registration memories to hold your favorite settings so that they can be recalled quickly by pressing a button.

The unit is equipped with a backup battery will not be lost when the power is turned off.

Please Note: The Registration Memory is recalled by using the numeric pad buttons.

SAVE YOUR SETTINGS IN THE REGISTRATION MEMORY

1. Set the voice, rhythm, tempo, accompaniment, reverb effect and any other parameters that you wish to save.

2. Hold down the REG button.

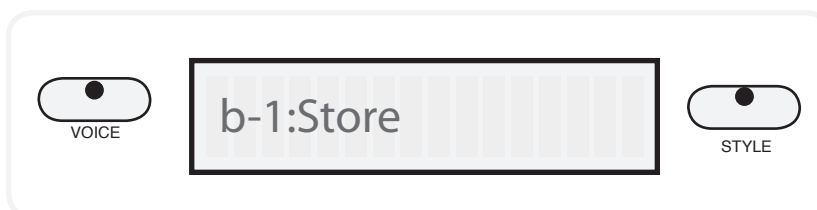

3. Press one of the number pads 1-9. The display will show the current registration memory number with a “b-” prefix. Your panel setting will be saved into that registration memory button instantly.

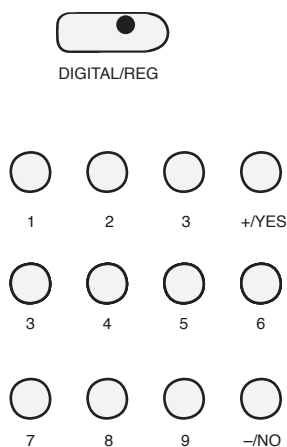

RECALL CONTENTS IN THE REGISTRATION MEMORY

1. Press and release the DIGITAL/REG button to engage the registration memory mode, the indicator will light up.

2. Press one of the number pads 1-9 buttons, the stored setting will be recalled instantly and the display will show the memory number with a “b-” prefix. The relevant parameters will be set and the display will recover to the voice that has just been recalled.

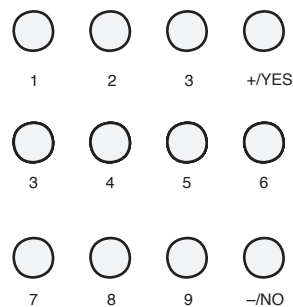
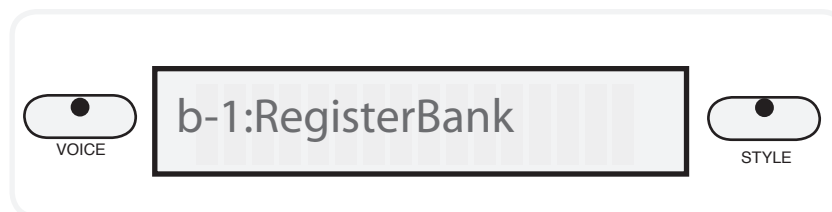

PLAY ALONG SONGS

Press the DEMO/SONG button twice to access the play along song function.

There are 50 songs built into the piano for your musical enjoyment.

You can change the song by pressing the +/YES , -/NO buttons or use the number pads to input a song number directly.

Press the DEMO/SONG button again to stop the song demonstration.



USING THE SONG FEATURE



DEMO/SONG



+ / YES



0



- / NO

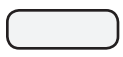

START/STOP



RIGHT



LEFT



LEFT



RIGHT



START/STOP



DEMO/SONG

1. Engage the Song mode - Press the DEMO/SONG button twice until green indicator lights up. The first song number will appear on the display.

Use the +/YES, -/NO buttons or the number pads to select a song. The song number will appear on the display.

001:Mary Lamb

2. Listen to the demonstration - Press the START/STOP button to listen to the selected song. The chord playing from the auto accompaniment and the tempo will be shown on the display.

Right hand play along - Press the RIGHT button. Then press the START/STOP button, after the metronome sound count in, the auto accompaniment will playback, and you can play the right hand melody notes with the rhythm accompaniment track. While playing, press the METRONOME button if you want to replace the drum part of the auto-accompaniment by the metronome.

If you want to play slower or faster than the preset tempo, press the TEMPO + or TEMPO - button to adjust the tempo. Press TEMPO+ and TEMPO- button simultaneously to return to the default tempo for the selected song.

PLAY ALONG SONGS

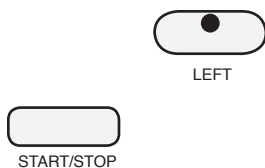

Left hand play along - Press the LEFT button. Then press the START/STOP button, after the metronome sound count in the melody will playback with the drum rhythm of the accompaniment track, you can play the left hand accompaniment pattern to match this melody. You may use METRONOME, TEMPO button as described above.

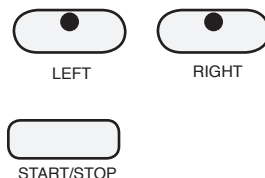

Right and Left hand play along- Press the RIGHT and LEFT buttons simultaneously, then press the START/STOP button, after the metronome sound, you can play the entire section with both hands with the percussive rhythm or metronome track.

You may use METRONOME, TEMPO button as described above.

- 3. Check you progress** - You will hear a vocal grading as soon as you finish the performance. The grades are "Try Again", "Good", "Very good" and "Excellent". You could disable the vocal grading in the Fuction manu.

The same song passage will continue until you press the START/STOP button.



- 4. Stop the Song Function** - Press the DEMO/SONG button again to exit the Play Along Song Mode.

iPOD DOCK

The iPod docking station is located on the right hand side of the piano underneath the keyboard.

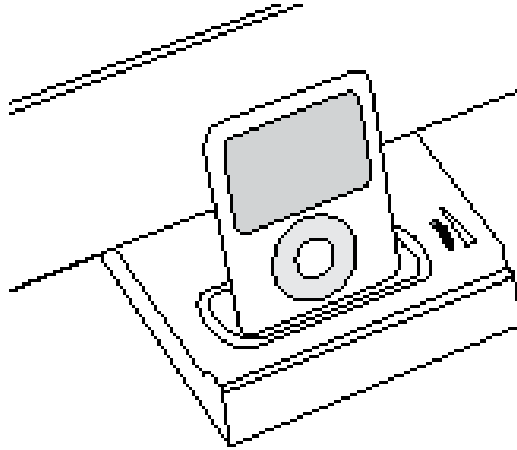

1. Pull out the iPod docking station from under the keyboard.
2. Turn the Piano's Master Volume to mid level to ensure that the initial iPod volume will not damage the Piano's sound delivery system.
3. Place your iPod onto the docking station carefully. The bottom of the iPod needs to interface with already compatible connector on the docking station.

iPod Volume

The volume control to the right of the iPod docking cradle can be used to easily adjust the iPod's volume to match your playing volume level, while you may use the master volume control for overall volume of the piano.

The Piano's EQ controls will not effect the iPod sound output. Therefore please use the iPod's EQ to optimize the iPod's sound and tone.

iPod Charging

Your iPod will be charging while it is connected to your piano's iPod docking station.

MIDI

MIDI stands for Musical Instrument Digital Interface. This is a world wide standard communication interface that enables electronic musical instruments and computers (of all brands) to communicate with each other so that instructions and other data can pass between them. This exchange of information makes it possible to create a system of MIDI instruments and devices that offers far greater versatility and control than is available with isolated instruments. Whether you interface with computers, sequencers, expanders or other keyboards your musical horizons will be greatly enhanced.

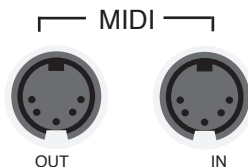

MIDI CONNECTION - The MIDI terminals are located on the left side panel of the piano.

1. **MIDI In:** This terminal receives MIDI data from an external MIDI device.
2. **MIDI Out:** This terminal transmits data from this instrument to other MIDI devices. The transmitted data includes the note and touch velocity produced while playing on the keyboard, as well as voice changes, wheel operation, and recorded playback for the melody tracks. Demo songs and auto accompaniment are not transmitted.

USB - The USB connector allows you to connect the piano directly to your computer. It can be connected without driver installation under the Windows XP, Windows Vista & MAC OSX environment. The piano will be recognized as a USB Audio device to receive and transmit the same MIDI messages described above.

For more information regarding transmitted MIDI data please see the next page and or the MIDI implementation chart.

MIDI CHANNELS - The MIDI system in this unit has 16 channels numbered from 1-16. Each of the channels is responsible for a voice. When the instrument receives from an external device, the active channel is determined by the control message. The transmission channels on this keyboard are fixed as follows:

Channel 1: Master voice

Channel 2: Layer voice

Channel 3: Split voice

Channel 4: Bass in manual bass chord mode

Channel 7: Chord in manual bass chord mode

Channel 10: Percussion sound

Please see the MIDI Implementation Chart for more detail.

For further MIDI setup options please see your local Suzuki Music Store.

Note: When the USB connected with computer, all MIDI message will receive/transmit via USB.

MIDI IMPLEMENTATION CHART

VOICE LIST

No.	Name	Display	030	Overdriven Guitar	Overdrive
PIANO			031	Distortion Guitar	Dist Guitar
001	Acoustic Grand Piano	Grand Piano	032	Guitar Harmonics	GtrHarmonics
002	Bright Acoustic Piano	Bright Piano	BASS		
003	Electric Grand Piano	El.G.Piano	033	Acoustic Bass	AcousticBass
004	Honky-Tonk Piano	Honky-Tonk Piano	034	Electric Bass (finger)	Finger Bass
005	Electric Piano 1	Elec. Piano1	035	Electric Bass (pick)	Pick Bass
006	Electric Piano 2	Elec. Piano2	036	Fretless Bass	FretlessBass
007	Harpsichord	Harpsichord	037	Slap Bass 1	SlapBass1
008	Clavichord	Clavichord	038	Slap Bass 2	SlapBass2
CHROMATIC PERCUSSION			039	Synth Bass 1	Synth Bass1
009	Celesta	Celesta	040	Synth Bass 2	Synth Bass2
010	Glockenspiel	Glockenspiel	No.	Name	Display
011	Music box	Music Box	STRINGS		
012	Vibraphone	Vibraphone	041	Violin	Violin
013	Marimba	Marimba	042	Viola	Viola
014	Xylophone	Xylophone	043	Cello	Cello
015	Tubular Bells	TubularBells	044	Contrabass	ContraBass
016	Dulcimer	Dulcimer	045	Tremolo Strings	Tremolo Strings
ORGAN			046	Pizzicato Strings	PizzStrings
017	Drawbar Organ	Draw Organ	047	Orchestral Harp	OrchHarp
018	Percussive Organ	Percus Organ	048	Timpani	Timpani
019	Rock Organ	Rock Organ	ENSEMBLE		
020	Church Organ	Church-Organ	049	String Ensemble 1	StringEnsb1
021	Reed Organ	Reed Organ	050	String Ensemble 2	StringEnsb2
022	Accordion	Accordion	051	Synth Strings 1	SynthString1
023	Harmonica	Harmonica	052	Synth Strings 2	SynthString2
024	Tango Accordion	Tango Accordion	053	Choir Aahs	ChoirAahs
GUITAR			054	Voice Oohs	VoiceOohs
025	Acoustic Nylon Guitar	Nylon Guitar	055	Synth Voice	Synth Voice
026	Acoustic Steel Guitar	Steel Guitar	056	Orchestra Hit	OrchHit
027	Electric Jazz Guitar	Jazz Guitar	BRASS		
028	Electric Clean Guitar	Clean Guitar	057	Trumpet	Trumpet
029	Electric Muted Guitar	Mute Guitar	058	Trombone	Trombone
			059	Tuba	Tuba
			060	Muted Trumpet	MutedTrumpet
			061	French Horn	FrenchHorn

VOICE LIST

More ethnic Asian Instruments have been added to the voice list as shown below.

097	FX 1 (rain)		Rain	
098	FX 2 (soundtrack)		Sound Track	
099	FX 3 (crystal)		Crystal	
100	FX 4 (atmosphere)		Atmosphere	
101	FX 5 (brightness)		Brightness	
102	FX 6 (goblins)		Goblins	
103	FX 7 (echoes)		Echoes	
104	FX 8 (sci-fi)		Sci-Fi	
			ETHNIC	
105	Sitar		Sitar	
106	Banjo		Banjo	
107	Shamisen		Shamisen	
108	Koto		Koto	
109	Kalimba		Kalimba	
110	Bagpipe		Bagpipe	

Please note: When the touch sensitivity is in the “Soft,” “Normal,” or “Hard,” mode, voice No. 137 will sound as Erhu when a key is struck softly, and as Yangqin when the key is struck hard.

If the touch response is fixed, voice No. 137 will always sound as Yangqin.

Voice No. 138 will sound as Zheng when a playing keys below C4, and as Dizi when playing key C4 and above.

STYLE LIST

No.	Name	No.	Name	No.	Name
	Swing	35	Disco Dance 1	70	Fox Trot
00	Swing 1	36	Disco Dance 2	71	Ragtime
01	Swingin'Organ	37	Disco Shuffle	72	Waltz 1
02	Swing Trio	38	Disco Groove	73	Waltz 2
03	Slow Swing	39	House	74	Classic 1
04	Dixie	40	Dance 1	75	Classic 2
05	Jazz	41	Dance Pop 1		BALLAD
06	Lounge	42	Dance Pop 2	76	Ballad
07.	Shuffle Blues	43	80's Dance	77	50's Ballad
08.	Blues	44	Dance 2	78	Power Ballad
	R&B	45	Techno	79	Jazz Ballad
09	Gospel 1	46	Rap	80	Bolero
10	Gospel 2		ROCK	81	Slow 16
11	Reggae 1	47	Rock1		ACOUSTIC
12	Reggae 2	48	Rock2	82	Kids 1
13	Motown	49	Slow Rock	83	Kids 2
14	Shuffle	50	Rock n Roll 1	84	March0 1
15	R&B 1	51	Rock n Roll 2	85	March0 2
16	R&B 2	52	Surf Rock	86	March0 3
17	R&B Shuf	53	Jerry	87	Polka 1
	POP		BOSSA	88	Polka 2
18	Pop 1	54	Bossa Nova	89	MexPolka
19	Pop 2	55	Bossa Nova 2	90	NewAge
20	Pop 3	56	Pop Bossa 1		ROCK
21	8 Beat Pop 1	57	Pop Bossa 2	91	Country
22	8 Beat Pop 2	58	Salsa	92	Country Train
23	8 Beat Pop 3	59	Tango	93	Bluegrass
24	Pop16	60	Merenque	94	SlowBlus
25	Pop Acoustic		LATIN		BIG BAND
26	EasyPop	61	Rumba	95	Latin Big Band
27	Funky Pop	62	Beguine	96	Brodway1
28	Disco Pop	63	Samba	97	Brodway2
29	Slow Groove	64	Chacha	98	Big band
30	Florida	65	Latin 1	99	Mambo Band
31	Folk 1	66	Latin 2		
32	Folk 2		OLDIES		
33	Funky	67	Hawaiian		
	DISCO	68	Hula		
34	Disco	69	Boogie		

DRUM KIT LIST-1

No.-Key	Standard (0) P-1: Standard	Room (8) P-2: Room	Power (16) P-3: Power	Electronic (24) P-4: Electronic	TR-808 (25) P-5: TR-808
27-E ^b 1	High Q	High Q	High Q	High Q	High Q
28-E1	Slap	Slap	Slap	Slap	Slap
29-F1	Scratch Push	Scratch Push	Scratch Push	Scratch Push	Scratch Push
30-F#1	Scratch Pull	Scratch Pull	Scratch Pull	Scratch Pull	Scratch Pull
31-G1	Stick	Stick	Stick	Stick	Stick
32-G#1	Square Click	Square Click	Square Click	Square Click	Square Click
33-A1	Metronome Click	Metronome Click	Metronome Click	Metronome Click	Metronome Click
34-B ^b 1	Metronome Bell	Metronome Bell	Metronome Bell	Metronome Bell	Metronome Bell
35-B1	Kick Drum 2	Kick Drum 2	Kick Drum 2	Kick Drum 2	Kick Drum 2
36-C2	Kick Drum 1	Kick Drum 1	Power Kick Drum	Elec Kick Drum	Synth Kick Drum 1
37-C#2	Side Stick	Side Stick	Side Stick	Side Stick	Synth Side Stick
38-D2	Snare Drum 2	Snare Drum 2	Power Snare Drum 2	Elec Snare Drum 2	Synth Snare Drum
39-E ^b 2	Hand Clap	Hand Clap	Hand Clap	Hand Clap	Hand Clap
40-E2	Snare Drum 1	Snare Drum 1	Power Snare Drum 1	Power Snare Drum 1	Snare Drum 1
41-F2	Low Floor Tom 2	Room Low Floor Tom 2	Low Floor Tom 2	Elec Low Floor Tom 2	Synth Low Floor Tom 2
42-F#2	Close Hi-hat	Close Hi-hat	Close Hi-hat	Close Hi-hat	Synth Close Hi-hat
43-G2	Low Floor Tom 1	Room Low Floor Tom 1	Low Floor Tom 1	Elec Low Floor Tom 1	Synth Low Floor Tom 1
44-G#2	Pedal Hi-hat	Pedal Hi-hat	Pedal Hi-hat	Pedal Hi-hat	Synth Pedal Hi-hat
45-A2	Low Tom	Room Low Tom	Low Tom	Elec Low Tom	Synth Low Tom
46-B ^b 2	Open Hi-hat	Open Hi-hat	Open Hi-hat	Open Hi-hat	Synth Open Hi-hat
47-B2	Low-mid Tom	Room Low-mid Tom	Low-mid Tom	Elec Low-mid Tom	Synth Low-mid Tom
48-C3	Hi-mid Tom	Hi-mid Tom	Hi-mid Tom	Elec Hi-mid Tom	Synth Hi-mid Tom
49-C#3	Crash Cymbal 1	Crash Cymbal 1	Crash Cymbal 1	Crash Cymbal 1	Synth Crash Cymbal 1
50-D3	RHigh Tom	R High Tom	High Tom	Elec High Tom	Synth High Tom
51-E ^b 3	Ride Cymbal 1	Ride Cymbal 1	Ride Cymbal 1	Ride Cymbal 1	Ride Cymbal 1
52-E3	Chinese Cymbal	Chinese Cymbal	Chinese Cymbal	Reverse Cymbal	Chinese Cymbal
53-F3	Ride Bell	Ride Bell	Ride Bell	Ride Bell	Ride Bell
54-F#3	Tambourine	Tambourine	Tambourine	Tambourine	Tambourine
55-G3	Splash Cymbal	Splash Cymbal	Splash Cymbal	Splash Cymbal	Splash Cymbal
56-G#3	Cowbell	Cowbell	Cowbell	Cowbell	Cowbell
57-A3	Crash Cymbal 2	Crash Cymbal 2	Crash Cymbal 2	Crash Cymbal 2	Crash Cymbal 2
58-B ^b 3	Vibra Slap	Vibra Slap	Vibra Slap	Vibra Slap	Vibra Slap
59-B3	Ride Cymbal 2	Ride Cymbal 2	Ride Cymbal 2	Ride Cymbal 2	Ride Cymbal 2
60-C4	Hi Bongo	Hi Bongo	Hi Bongo	Hi Bongo	Hi Bongo
61-C#4	Low Bongo	Low Bongo	Low Bongo	Low Bongo	Low Bongo
62-D4	Mute Conga	Mute Conga	Mute Conga	Mute Conga	Mute Conga
63-E ^b 4	Hi Conga	Hi Conga	Hi Conga	Hi Conga	Hi Conga
64-E4	Low Conga	Low Conga	Low Conga	Low Conga	Low Conga
65-F4	High Timbale	High Timbale	High Timbale	High Timbale	High Timbale
66-F#4	Low Timbale	Low Timbale	Low Timbale	Low Timbale	Low Timbale
67-G4	High Agogo	High Agogo	High Agogo	High Agogo	High Agogo
68-G#4	Low Agogo	Low Agogo	Low Agogo	Low Agogo	Low Agogo
69-A4	Cabasa	Cabasa	Cabasa	Cabasa	Cabasa
70-B ^b 4	Maracas	Maracas	Maracas	Maracas	Maracas
71-B4	Short Whistle	Short Whistle	Short Whistle	Short Whistle	Short Whistle
72-C5	Long Whistle	Long Whistle	Long Whistle	Long Whistle	Long Whistle
73-C#5	Short Guiro	Short Guiro	Short Guiro	Short Guiro	Short Guiro
74-D5	Long Guiro	Long Guiro	Long Guiro	Long Guiro	Long Guiro
75-E ^b 5	Claves	Claves	Claves	Claves	Claves
76-E5	Hi Wood Block	Hi Wood Block	Hi Wood Block	Hi Wood Block	Hi Wood Block
77-F5	Low Wood Block	Low Wood Block	Low Wood Block	Low Wood Block	Low Wood Block
78-F#5	Mute Cuica	Mute Cuica	Mute Cuica	Mute Cuica	Mute Cuica
79-G5	Open Cuica	Open Cuica	Open Cuica	Open Cuica	Open Cuica
80-G#5	Mute Triangle	Mute Triangle	Mute Triangle	Mute Triangle	Mute Triangle
81-A5	Open Triangle	Open Triangle	Open Triangle	Open Triangle	Open Triangle
82-B ^b 5	Cabasa	Cabasa	Cabasa	Cabasa	Cabasa
83-B5	Shaker	Shaker	Shaker	Shaker	Shaker
84-C6	Belltree	Belltree	Belltree	Belltree	Belltree
85-C#6	Castanets	Castanets	Castanets	Castanets	Castanets
86-D6	Mute Surdo	Mute Surdo	Mute Surdo	Mute Surdo	Mute Surdo
87-E ^b 6	Open Surdo	Open Surdo	Open Surdo	Open Surdo	Open Surdo

DRUM KIT LIST-2

No.-Key	Jazz (32) P-6: Jazz	Brush (40) P-7: Brush	Orchestra (48) P-8: Orchestra	Chinese (58) P-9: Chinese	Effects (56) P-10: SFX
27-E ^b 1	High Q	High Q	Close Hi-hat	High Q	
28-E1	Slap	Slap	Pedal Hi-hat	Slap	
29-F1	Scratch Push	Scratch Push	Open Hi-ha	Scratch Push	
30-F#1	Scratch Pull	Scratch Pull	Ride Cymbal	Scratch Pull	
31-G1	Stick	Stick	Stick	Stick	
32-G#1	Square Click	Square Click	Square Click	Square Click	
33-A1	Metronome Click	Metronome Click	Metronome Click	Metronome Click	
34-B ^b 1	Metronome Bell	Metronome Bell	Metronome Bell	Metronome Bell	
35-B1	Jazz Bass Drum	Jazz Bass Drum	Orche Bass Drum 2	Jazz Bass Drum	
36-C2	70 Bass Drum 1	70 Bass Drum	Orche Bass Drum 1	70 Bass Drum 1	
37-C#2	Side Stick	Side Stick	Side Stick	Side Stick	
38-D2	Snare Drum 2	Brush Tap	Orche Snare Drum 2	Snare Drum 2	
39-E ^b 2	Hand Clap	Brush Slap	Casstanets	Hand Clap	High-Q
40-E2	Snare Drum 1	Brush Swirl	Orche Snare Drum 1	Snare Drum 1	Slap
41-F2	Low Floor Tom 2	Low Floor Tom 2	Timpani F	Low Floor Tom 2	Scratch Push
42-F#2	Close Hi-hat	Close Hi-hat	Timpani F#	Close Hi-hat	Scratch Pull
43-G2	Low Floor Tom 1	Low Floor Tom 1	Timpani G	Low Floor Tom 1	Stick
44-G#2	Pedal Hi-hat	Pedal Hi-hat	Timpani G#	Pedal Hi-hat	Square Click
45-A2	Low Tom	Low Tom	Timpani A	Low Tom	Metronome Click
46-B ^b 2	Open Hi-hat	Open Hi-hat	Timpani A#	Open Hi-hat	Metronome Bell
47-B2	Low-mid Tom	Low-mid Tom	Timpani B	Low-mid Tom	Gtr. Cut Noise1 (down)
48-C3	Hi-mid Tom	Hi-mid Tom	Timpani C	Hi-mid Tom	Gtr. Cut Noise2 (up)
49-C#3	Crash Cymbal 1	Crash Cymbal 1	Timpani C#	Crash Cymbal 1	Bass Slap
50-D3	High Tom	High Tom	Timpani D	High Tom	Bass Pick
51-E ^b 3	Ride Cymbal 1	Ride Cymbal 1	Timpani D#	Ride Cymbal 1	Key Click
52-E3	Chinese Cymbal	Chinese Cymbal	Timpani E	Chinese Cymbal	Laughing
53-F3	Ride Bell	Ride Bell	Timpani F	Ride Bell	Screaming
54-F#3	Tambourine	Tambourine	Tambourine	Tambourine	Punch
55-G3	Splash Cymbal	Splash Cymbal	Splash Cymbal	Splash Cymbal	Heart Beat
56-G#3	Cowbell	Cowbell	Cowbell	Cowbell	Footstep 1
57-A3	Crash Cymbal 2	Crash Cymbal 2	Orche Crash Cymbal	Crash Cymbal 2	Footstep 2
58-B ^b 3	Vibra Slap	Vibra Slap	Vibra Slap	Vibra Slap	Applause
59-B3	Ride Cymbal 2	Ride Cymbal 2	Orche Cymbal	Ride Cymbal 2	Door Creaking
60-C4	Hi Bongo	Hi Bongo	Hi Bongo	Hi Bongo	Door Closing
61-C#4	Low Bongo	Low Bongo	Low Bongo	Low Bongo	Scratch
62-D4	Mute Conga	Mute Conga	Mute Conga	Mute Conga	Wind Chime
63-E ^b 4	Hi Conga	Hi Conga	Hi Conga	Hi Conga	Car Engine Starting
64-E4	Low Conga	Low Conga	Low Conga	Low Conga	Car stop
65-F4	High Timbale	High Timbale	High Timbale	High Timbale	Car Pass
66-F#4	Low Timbale	Low Timbale	Low Timbale	Low Timbale	Car Crash
67-G4	High Agogo	High Agogo	High Agogo	High Agogo	Siren
68-G#4	Low Agogo	Low Agogo	Low Agogo	Low Agogo	Train
69-A4	Cabasa	Cabasa	Cabasa	Cabasa	Jet Plane
70-B ^b 4	Maracas	Maracas	Maracas	Maracas	Helicopter
71-B4	Short Whistle	Short Whistle	Short Whistle	Short Whistle	Starship
72-C5	Long Whistle	Long Whistle	Long Whistle	Long Whistle	Gun Shot
73-C#5	Short Guiro	Short Guiro	Short Guiro	Short Guiro	Machingun
74-D5	Long Guiro	Long Guiro	Long Guiro	Long Guiro	Laser Gun
75-E ^b 5	Claves	Claves	Claves	Claves	Explosion
76-E5	Hi Wood Block	Hi Wood Block	Hi Wood Block	Hi Wood Block	Dog
77-F5	Low Wood Block	Low Wood Block	Low Wood Block	Low Wood Block	Horse Gallop
78-F#5	Mute Cuica	Mute Cuica	Mute Cuica	Mute Cuica	Birds
79-G5	Open Cuica	Open Cuica	Open Cuica	Open Cuica	Rain
80-G#5	Mute Triangle	Mute Triangle	Mute Triangle	Mute Triangle	Thunder
81-A5	Open Triangle	Open Triangle	Open Triangle	Open Triangle	Wind
82-B ^b 5	Cabasa	Cabasa	Cabasa	Chi	Sea Shore
83-B5	Shaker	Shaker	Shaker	Da	Stream
84-C6	Belltree	Belltree	Belltree	Gong	Bubble
85-C#6	Castanets	Castanets	Castanets	Xiao cha 1	
86-D6	Mute Surdo	Mute Surdo	Mute Surdo	Dagu	
87-E ^b 6	Open Surdo	Open Surdo	Open Surdo	Xiao cha mute 1	
88-E6				Hey	
89-F6				Pai gu Low	
90-F#6				Xiao cha 2	
91-G6				Pai gu Mid	
92-G#6				Xiao cha mute 2	
93-A6				Pai gu Hi	
94-B ^b 6				Jing Luo mute	
95-B6				Jing Luo	
96-C7				Xiao Luo	

DRUM KIT LIST

Please Note: For the drum kit lists on the previous two pages, in the first title row, the number in the bracket, after the kit name, is the MIDI program number. The Drum kits name and number that are shown on the LCD display are listed in the second title row.

The “No.” refers to MIDI note number, and “Key” refers to the key on the keyboard.

Keys from A1 to D2 sound as timpani, except for in Kit 10, the effects kit.

Keys from E6 to C7 sound the same as the D#1 to B2 keys, except for Kit 9, the Chinese kit.

A list of the sounds of E6 to C7 for Kit 9, Chinese kit are listed below.

KIT 9 COMPLEMENT

No. - Key	Sound
88-E5	Drum + Hey!
89-F5	Low Pai Gu
90-F#5	Small Cymbal
91-G5	Mid Pai Gu
92-G#5	Mute Small Cymbal
93-A5	High Pai Gu
94-Bb5	Mute Jing Gong
95-B5	Jing Gong
96-C6	Small Gong

PEDALS

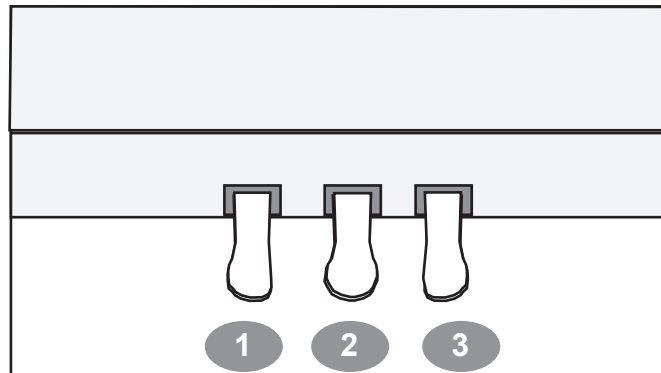

PIANO PEDALS

1. **SOFT PEDAL** - When the left pedal is engaged the piano volume is reduced and the timbre slightly altered on the notes that are played.
2. **FUNCTION PEDAL** - This center pedal can be used to trigger various events, such as start/stop and Fill In. Pedal function is assigned in the setup menu, "Pedal Assign". Please see the Setup section of this manual for more information.
3. **SUSTAIN PEDAL** - When the right pedal is engaged the piano keys will continue to sustain as they are played. Thereby the piano note will decay gradually) as if you were continuing to hold down the piano keys.

SPECIFICATIONS

KEYBOARD

88-note, Graded hammer-action keyboard

MAX. POLYPHONY WITH SOUND EFFECTS: 64

VOICES

138 Voices

(Including ten Asian folk instrument voices)

5 quick select voice buttons + A/B select

VOICE MODE

Layer (dual) voice

Lower (split) voice

VOICE EFFECTS

Reverb

Chorus

NUMERIC PAD: 12

DISPLAY: 16-Character LCD

REGISTRATION MEMORY: 9

DEMONSTRATION: 13 songs,

RECORDING: Four songs, 3 track recording

OVERALL CONTROL

Transpose

Tempo

Main Volume Control: Min-Max

Accomp Volume Control: Min-Max

Setup

AUTO BASS CHORD MODE

Single

Fingered

Piano

Off

AUTO ACCOMPANIMENT STYLE

100 Auto accompaniment styles

5 quick select style buttons + A/B select

ACCOMPANIMENT CONTROL

Synchro start

Start/Stop

Introduction

Ending

Fill-In

Variation

Metronome

Auto harmony (four types)

PLAY ALONG SONGS

50 songs

Right hand, left hand or both hands performance

Vocal grading

FUNCTION

Equalization

Reverb Type & level

Chorus Type & level

Touch Sensitivity

Split point for voice

Split point for auto accompaniment

Master Tune

Drum kit selection

Harmony type selection

Local Off

Factory Setting

EXTERNAL MEMORY

USB Flash drive

AUXILIARY JACKS

Headphone x 2

Line Out

Line In

Power In

MIDI In/Out

USB

Microphone In

PEDALS

Sustain Pedal

Sostenuto Pedal

Soft Pedal

AMPLIFIER: 60W x 2

DIMENSIONS

1406mm x 717mm x 900mm