

User's Manual

Princeton HP-11 DIGITAL PIANO

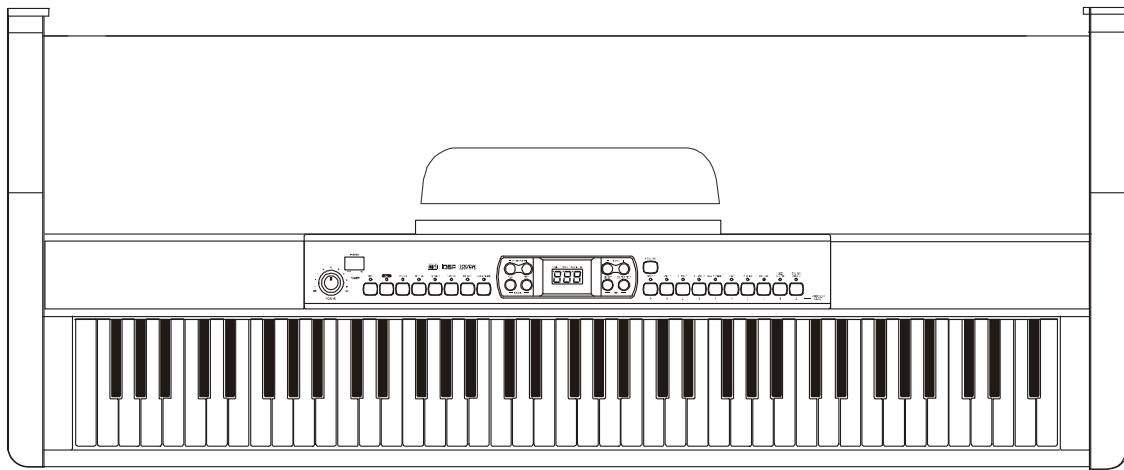

Using Your Instruction Manual

Congratulations on the purchase of your new digital piano! With your new piano, you'll enjoy breakthrough technology and advanced sound reproduction – bringing you professional performance and entertainment wrapped in one! This skillfully built digital piano enables you to explore your creativity, and helps make yours a more musical home...

Before using your new piano, we recommend you read through this manual completely and keep it handy for future reference.

Precautions

Please read the following carefully before use:

- ✧ Do not expose the piano to high temperature, direct sunlight or excessive dust.
- ✧ Do not place the piano too close to appliances such as televisions and radios as these items may cause interference.
- ✧ Avoid excessive humidity and putting any liquids on top of the piano
- ✧ Always unplug AC cord by gripping the plug firmly, but not pulling on the cable.
- ✧ Do not apply excessive force to the switches and buttons.
- ✧ When the piano is not in use or during a thunderstorm, please disconnect the power supply.
- ✧ Maintain the volume at a comfortable level - we recommend you limit this to two-thirds of the maximum to prevent damage to your ears
- ✧ Unplug the power cable before cleaning the piano. Do not connect or disconnect the power cable with wet hands.
- ✧ Check and clean the power plug periodically.
- ✧ To avoid damage to the piano and other devices to which it is connected, turn the power switches of all related devices off prior to connecting or disconnecting cables.
- ✧ Clean the piano and remove the dust with a dry soft cloth or a slightly damp cloth.
- ✧ Never use cleaners such as thinner or alcohol. To prevent any damage on the surface of the LED display, please use lens cleaning tissue to clean the display.
- ✧ If the piano cable is damaged, please do not use the piano as it presents a fire or electrical hazard.
- ✧ If the piano malfunctions due to improper handling, please switch off, wait 30 seconds, and switch on again.
- ✧ Do not attempt to disassemble or repair the piano by yourself. If the piano does not work properly, please contact an authorized service technician.
- ✧ The piano should not be exposed to water, rain, liquids, etc.. Do not place any object filled with liquids on the piano.

Contents

Digital Piano Set-up Guide	3-5
General Guide	6-7
The Connectors	8
- Using the AC power jack	8
- Using Headphones	8
- Using the MIDI OUT jack	8
Operation	9-13
1. Power Switch & Volume	9
2. Voice/Dual Voice	9
3. Metronome	9
4. DSP (Digital Signal Processor)	10
5. Transpose	10
6. Tempo	10
7. Touch Response	10
8. Record & Playback	11-12
9. Demo Song	12-13
10. Foot Pedals	13
MIDI	14
- What is MIDI?	14
- What can you do with MIDI?	14
Specifications	15
Voice List	16
Demo Song List	16

Digital Piano Set-up Guide

1. Open the package, and check that you have the following parts:

1. Piano body
2. Music stand
3. Right leg
4. Left leg
5. Back panel
6. Foot pedal unit
7. Hand screw (4 pcs.)
8. Screws (8 pcs.)
9. Screw caps (8 pcs.)
10. Power cable stabiling hook (2 pcs.)

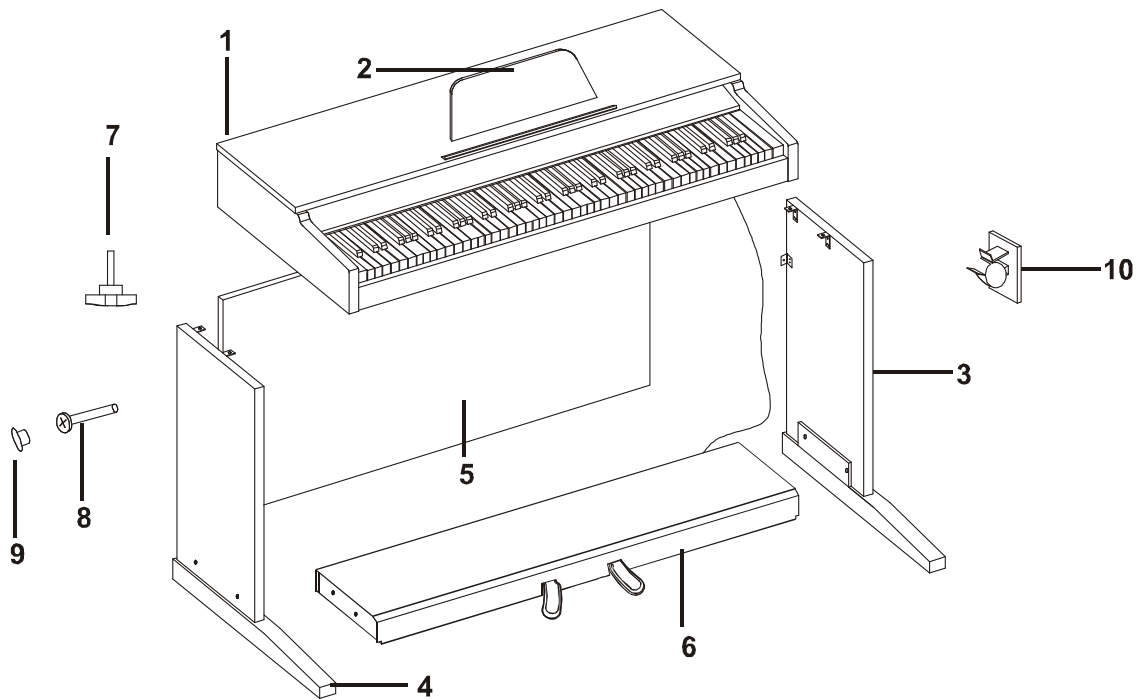

Digital Piano Set-up Guide

2. Follow the illustration below to setup your piano.

A.

Put the foot pedal unit(6) in between the left and right legs (3&4) . Use 4 screws (2 on each side) to attach the legs onto the foot pedal unit.

(Make sure the position correct before tightening screws)

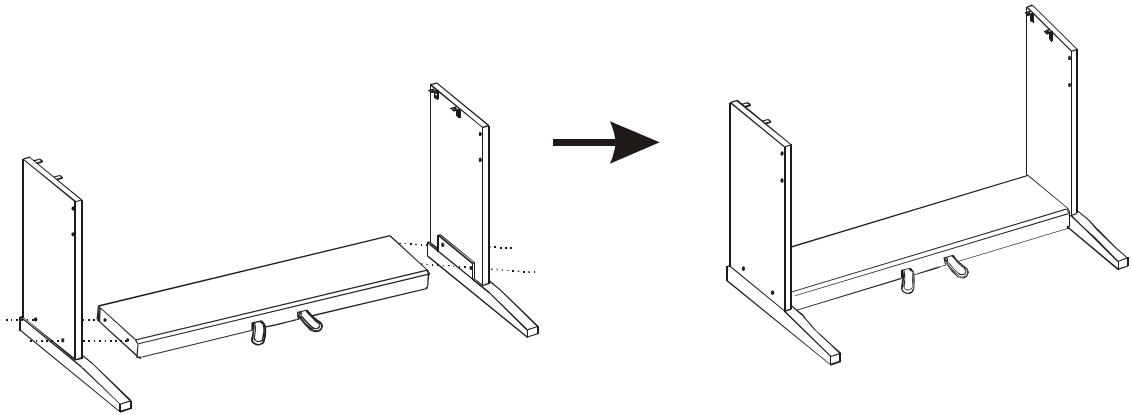

B.

Use 4 screws (2 on each side) to tighten the back panel (5) onto the finished assembly in Part A.

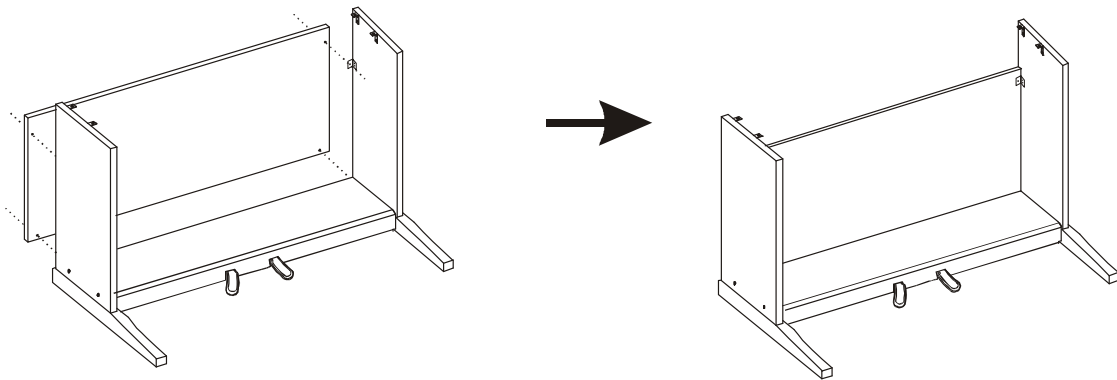

Digital Piano Set-up Guide

C.

Put the piano body (1) on the top of the finished stand from part B. Use 4 hand screws to fasten the piano to the stand.

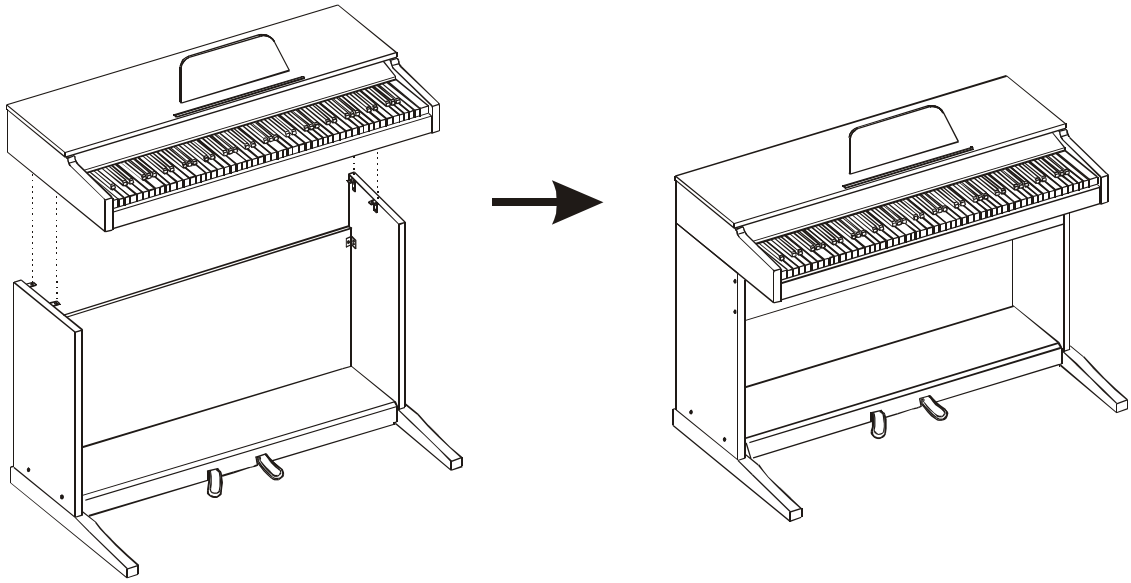

D.

Fasten the cable stabiling hook(10) on the internal side of the legs (see the illustration below for reference).

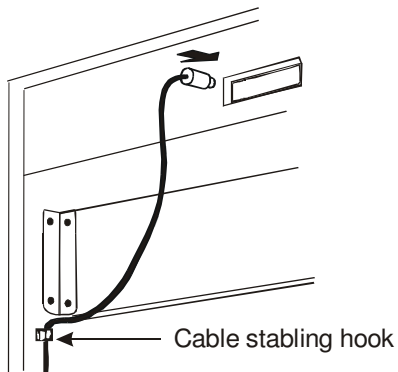

General Guide

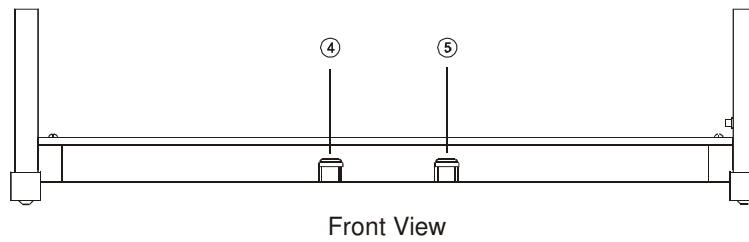
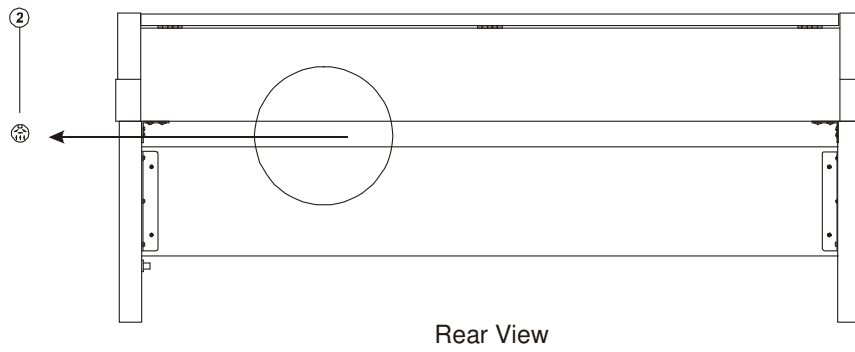
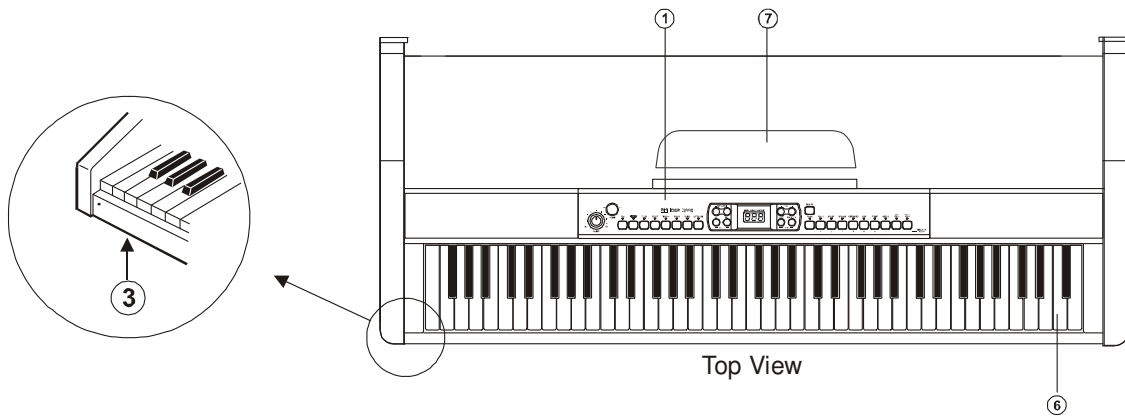

1. Control Panel
2. MIDI OUT Jack
3. Headphones Jack
4. Soft Pedal
5. Sustain Pedal
6. Piano Keyboard
7. Music Stand

General Guide

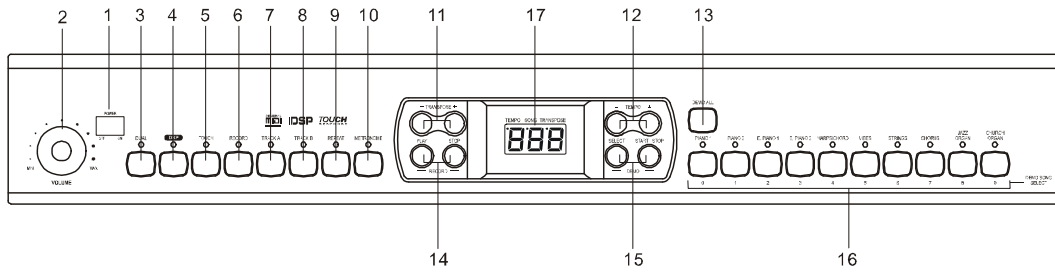

- | | |
|-------------------|-----------------------------------|
| 1) POWER SWITCH | 16) VOICE TYPE & DEMO SONG SELECT |
| 2) MASTER VOLUME | 0 - PIANO 1 |
| 3) DUAL | 1 - PIANO 2 |
| 4) DSP | 2 - E.PIANO 1 |
| 5) TOUCH | 3 - E.PIANO 2 |
| 6) RECORD | 4 - HARPSICHORD |
| 7) TRACK A | 5 - VIBES |
| 8) TRACK B | 6 - STRINGS ENSEMBLE |
| 9) REPEAT | 7 - CHORUS |
| 10) METRONOME | 8 - JAZZ ORGAN |
| 11) TRANSPOSE +/- | 9 - CHURCH ORGAN |
| 12) TEMPO +/- | 17) LED |
| 13) DEMO ALL | - TEMPO |
| 14) RECORD | - SONG |
| - PLAY | - TRANSPOSE |
| - STOP | |
| 15) DEMO | |
| - SELECT | |
| - START/STOP | |

The Connectors

Using the AC power jack

Ensure the piano is turned off when connecting and disconnecting the power



Plug the power cable into an AC power outlet.

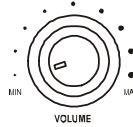

Turn the volume switch anti-clockwise to reach the minimum volume level.

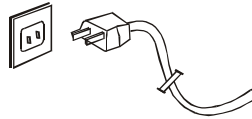

If you have done the above procedures, it is now safe to turn on the piano.

Caution:

When the piano is not in use or during a thunderstorm, disconnect the power for safety sake.

Using Headphones

There are two headphones jacks on the left side underneath the piano. When an optional set of stereo headphones is connected with the headphones in jack 2, the sound from the speakers will switch off automatically so that the sound is only heard in the headphones.

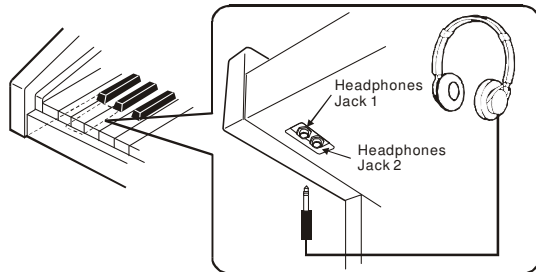

When jack 1 is connected with the stereo headphones, the sound can be heard from both headphones and the speakers of the piano.

Caution:

Never use headphones at high volume, as it may damage your sense of hearing.

To prevent damage to the speakers, ensure that the volume is set to the minimum level before connecting the power and other devices.

Using the MIDI OUT Jack

MIDI stands for Musical Instrument Digital Interface. MIDI is a world wide standard that makes it possible to connect various electronic musical instruments and other devices.



MIDI OUT:

Data produced by the Digital Piano is transmitted to other MIDI instruments via MIDI from this terminal.

Operation

1. Power Switch & Volume

1. Turn the POWER switch on.
The LED display lights up.

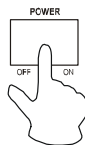

2. Use the volume control switch to adjust the volume to your desired level



Caution:

If the LED display has not lit up after you turned on the piano, please check the power supply.

If the piano is silent, the volume may be adjusted to its minimum level.

Although Main switch is in OFF position, the piano is not disconnected from the power supply completely!

2. Voice/Dual Voice

- ❖ Select a voice by pressing one of the [VOICE TYPE] buttons, the corresponding indicator will lighten up and the number of the selected voice will appear in the LED.
- ❖ Press the [DUAL] button to enter the Dual Voice mode, then select the second voice by pressing a [VOICE TYPE] button.
- ❖ To quit the Dual Voice mode, press the [DUAL] button again.
- ❖ While recording, Voice 2 will turn off automatically.

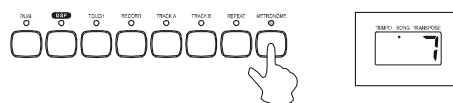
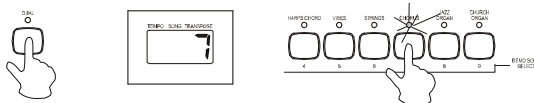
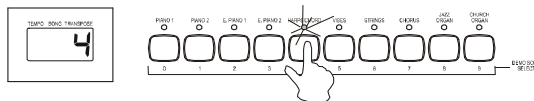

3. Metronome

- ❖ Press the [METRONOME] button to turn on/off the metronome function.
- ❖ You cannot use the metronome function when the DEMO song is playing.
- ❖ To turn off the metronome, press the [STOP] button.

4. DSP (Digital Signal Processor)

- ✧ Press the [DSP] button to turn on/off the DSP. The status will appear on the LED.

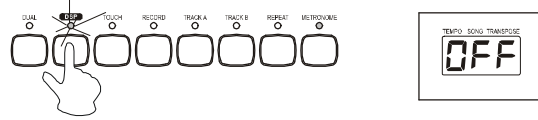

5. Transpose

- ✧ The Transpose function allows you to change the pitch of the instrument in semi-tone steps, up to a maximum setting of 12 semitones above or below standard pitch.
- ✧ To restore the normal Transpose position, press both the +/- buttons simultaneously.

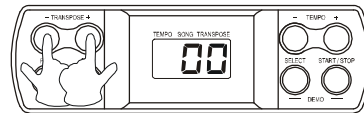
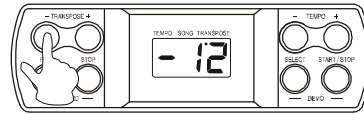

6. Tempo

- ✧ You can speed up or slow down the tempo of a song or metronome by pressing the [TEMPO +/-] buttons.
- ✧ To restore the default tempo, press both the +/- buttons simultaneously. When you press both the +/- buttons when the song/metronome is stopping, the tempo will return to 120.
- ✧ When you are adjusting the tempo, the tempo indicator will appear on the display.

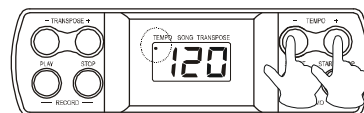
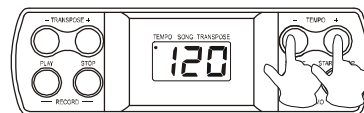
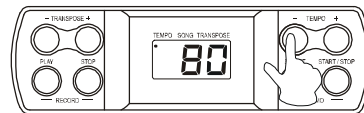

7. Touch Response

- ✧ Press the [TOUCH] button to adjust the touch response level in the range of 1 to 3. 2 is the default level.
- ✧ To turn off the touch response function, press the [TOUCH] button repeatedly until "OFF" appears on the display.

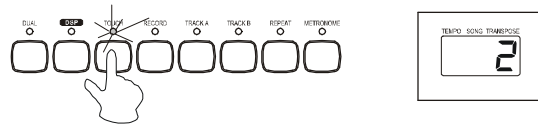

8. Record & Playback

Record

- ✧ Press the [RECORD] button to record. The record indicator lights up.
- ✧ There are 2 tracks for recording - track A and track B. Select and press [TRACK A] or [TRACK B] button to save your recording.
- ✧ To remove the recorded data and record again, press the [RECORD] and [TRACK A] or [TRACK B] simultaneously. Their indicators light up and flash.
- ✧ Play a key on the keyboard to start recording.
- ✧ To stop recording, press the [STOP] button.

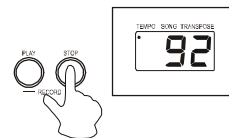
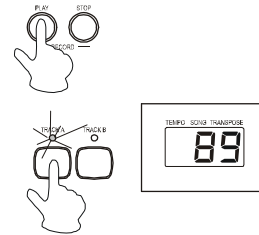
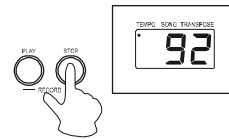
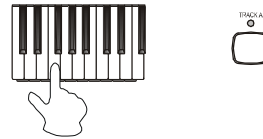
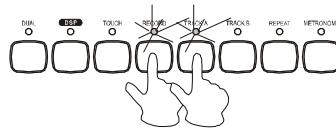

Playback

- ✧ Select and press the track you want to playback. Its indicator will light.
- ✧ To stop the playback, press the [RECORD - STOP] button.
- ✧ Press the [RECORD-PLAY] button to start playing back the track.

Repeat the playback

During the playback, press the [REPEAT] button to set the start point that you want to listen, "r-A" will appear on the display, then press the [REPEAT] button again to set the end point of the playback, "r-B" will appear on the display and the recorded song will playback repeatedly.

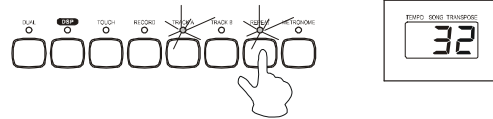

9. Demo Song

Select a Demo song

- ✧ Hold the [SELECT] button.
- ✧ The number of the current demo song will appear on the display.
- ✧ Use the Voice Select buttons (0-9) to select your desired demo song. You must enter a 2-digit number (00-19).

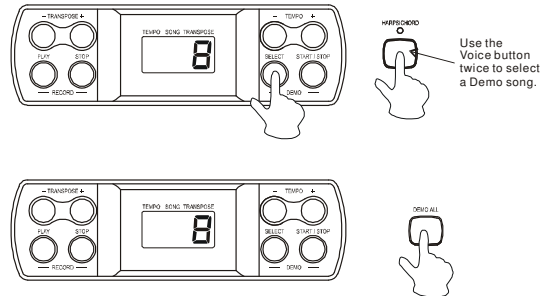

Play the demo songs in sequence

- ✧ Press the [DEMO ALL] button to start playing the demo songs in sequence. To stop the demo songs, press the [DEMO ALL] or [START/STOP] button.
- ✧ When the demo songs is playing, you can not change it to another one immediately.



Select a track of the demo song

- ✧ While the demo song is playing, you can deactivate the corresponding track by pressing the [TRACK A] or [TRACK B] button.
- ✧ No sound will play if both tracks are deactivated.
- ✧ Press the track button again to play the demo song.

Repeat the demo song

- ✧ While a demo song is playing, press the [REPEAT] button to set the beginning point that you want to listen. "r-A" will appear on the display, then press the [REPEAT] button again to set the end point of the playback."r-B" will appear on the display and the selected section of the demo song will playback repeatedly.

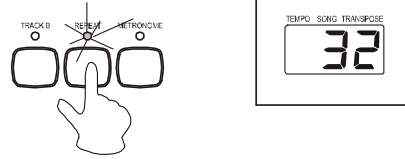

- ✧ This function does not work after pressing the [DEMO ALL] button and its songs are playing.

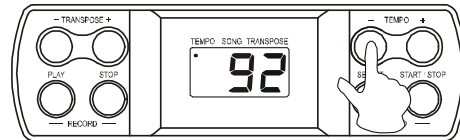

Adjust the tempo of demo song

- ✧ When a demo song is playing, you can adjust its tempo by pressing the [TEMPO +/-] buttons.

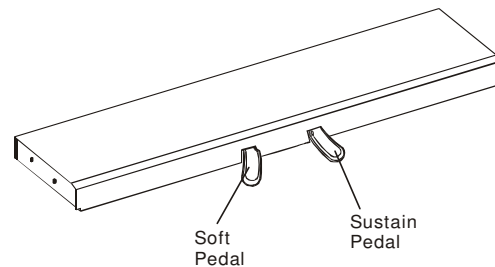

10. Foot pedals

The piano has 2 foot pedals - soft pedal and sustain pedal.

MIDI

The MIDI OUT terminal is located at the rear panel of the unit.

The following shows the description of MIDI and the steps of using the MIDI function.

What is MIDI?

MIDI stands for Musical Instrument Digital Interface. MIDI is a world wide standard that makes it possible for various electronic musical instruments and other devices, such as computers, to "communicate with each other".

The keyboard is equipped with one type of MIDI terminals, is located on the rear panel.

MIDI OUT

Data produced by the keyboard, is transmitted to other MIDI instruments via MIDI from this terminal.



What can do with MIDI?

Record data by using the Auto Accompaniment on an external sequencer .

After recording, you can edit the data with the sequencer.

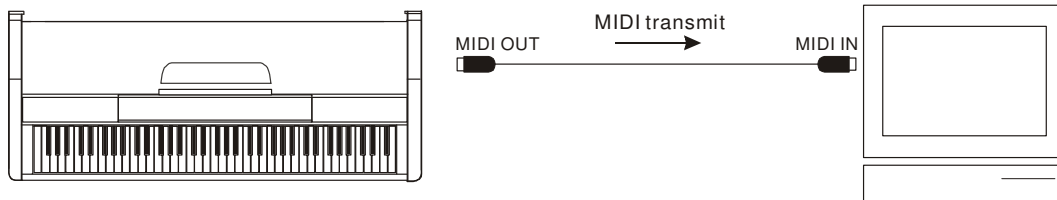

Play music from another keyboard .



Specifications

Keyboard	88 hammer action keys
Voice	10 Voices
Demo Song	20 Demo Songs
Display	LED
Switch and Buttons	POWER SWITCH, VOLUME SWITCH, DUAL, DSP, TOUCH, RECORD, TRACK A, TRACK B, REPEAT, METRONOME, TRANSPOSE +/-, TEMPO +/-, DEMO ALL, RECORD - PLAY/STOP, DEMO - SELECT/ START/STOP, VOICE SELECT 0-9
Transpose	12 semi tones
Pedals	Soft, Sustain
Touch Response	Hard, Medium, Soft, Off
Connectors	AC POWER, HEADPHONES, MIDI OUT, PEDALS
Speaker	8ohm 25w x 2
Dimension	54" x 20" x 33"
Weight	136 lbs

Voice List

No	Name of Voice	Name of Voice on Panel
0	Acoustic Grand Piano	PIANO 1
1	Bright Acoustic Piano	PIANO 2
2	E. Piano 1	E. PIANO 1
3	E. Piano 2	E. PIANO 2
4	Harpsichord	HARPS.
5	Vibraphone	VIBES
6	Strings Ensemble	STRINGS
7	Chorus	CHORUS
8	Jazz Organ	JAZZ ORGAN
9	Church Organ	CHURCH ORGAN

Demo Song List

00	GIPSY RONDO
01	TOCCATA
02	MAPLE LEAF RAG
03	THE STING
04	MINUET 1
05	SPRING
06	VOICES OF SPRING
07	HALELUYA
08	BABY ELEPHANT WALK
09	WEDDING MARCH
10	ANDANTE [SURPRISE] SYMPHONY
11	TURKISH MARCH
12	SONATINA MOVEMENT
13	MINUET 2
14	THE LAST ROSE OF SUMMER
15	CLELITO LINDO
16	BEAUTIFUL DREAMER
17	WEBER'S LAST THOUGHT
18	JOY TO THE WORLD
19	TRINITY